

**AUTO-RADIO NUMBER**



*July*  
**25 Cents**  
*Canada 30c*

# Radio-Craft

**HUGO GERNSBACK** Editor



**RADIO DEVICE  
GUIDES THE BLIND**

See Page 12

**Complete New Auto-Radio Data with Installation and Service Notes—All-Wave Antennas—A Set Sensitivity Tester—A 3 Tube A. C. Short-Wave Receiver**

**RADIO'S LIVEST MAGAZINE**

# ANNOUNCING

## A GOLDEN OPPORTUNITY FOR ALERT RADIO MEN IN THE NEXT GREAT INDUSTRY



PRE-PUBLICATION  
OFFER

\$4.00

THE idea of electricians, radio service men and other mechanically inclined men, servicing Air Conditioning and Refrigeration Units is self-evident and the thought has occurred to some untold thousands ever since air conditioning equipment has been installed in public auditoriums, theatres, studios, department stores, office buildings and manufacturing plants. The tremendously broad possibilities in this new industry are bound to give employment and success to men far-sighted enough to see its advancement and development. We quote an excerpt from Mr. Hugo Gernsback's editorial which appeared in the September, 1933 issue of *Everyday Science and Mechanics*:

*"I advise young and progressive men to go into the air-conditioning business during the next few years; because, this, without a doubt, is the coming industry in this country. Thousands of small firms will spring up, undertaking to air-condition private houses, small business offices, factories, etc. We are not going to tear down every building in the United States immediately. It will be a gradual growth; yet small installation firms will air-condition small houses, and even single offices in small buildings."*

This is only partial proof of the certain success of this new field. Further assurance is that engineering schools have already added many important courses on air conditioning to their regular curriculum. Architects and building contractors are giving considerable thought to installation of this equipment in structures which are now being planned and built. The beginning of this business will probably be similar to the auto and radio industry, but in a few short years it will surpass these two great fields.

## Official Air Conditioning Service Manual

352 Pages  
Over 600 Illustrations  
9" x 12" in Size  
Flexible, Loose Leaf  
Leatherette Cover



The OFFICIAL AIR CONDITIONING SERVICE MANUAL is being edited by L. K. Wright, who is an expert and a leading authority on air conditioning and refrigeration. He is a member of the American Society of Refrigerating Engineers, American Society of Mechanical Engineers, National Association of Practical Refrigerating Engineers; also author of the OFFICIAL REFRIGERATION SERVICE MANUAL and other volumes.

In this Air Conditioning Service Manual nearly every page will be illustrated; every modern installation and individual part carefully explained; diagrams furnished of all known equipment; special care given to the servicing and installation end. The tools needed will be illustrated and explained; there will be plenty of charts and page after page of service data.

Remember there is a big opportunity in this new field and plenty of money to be made in the servicing end. There are thousands of firms selling installations and parts every day and this equipment must be cared for frequently. Eventually air conditioning systems will be as common as radios and refrigerators in homes, offices and industrial plants. Why not start now—increase your earnings with a full- or spare-time service business.

You have the opportunity to get your copy of the OFFICIAL AIR CONDITIONING SERVICE MANUAL today—at a saving of ONE DOLLAR. When the book comes off press, which will be July 1st, the price will be \$5.00 a copy. YOUR ORDER TODAY BRINGS YOU A COPY FOR \$4.00. POSTAGE PREPAID. This is our usual courtesy, pre-publication offer which enables us to determine the approximate print order for the first press run. Send us the coupon today, together with a deposit of \$2.00. When the book reaches you, you pay the other \$2.00.

Here are some of the chapter heads of the AIR CONDITIONING SERVICE MANUAL:

### Contents in Brief

History of Air Conditioning; Fundamental Laws; Methods of Refrigeration; Ejector System of Refrigeration; Compression System of Refrigeration; Refrigerants; Lubricating Oils; Liquid Throttle Devices; Servicing Expansion and Float Valves; Servicing Refrigerating Systems; Control Devices; Thermodynamics of Air Conditioning; Weather in the United States; The Field of Air Conditioning; Insulating Materials; Heat Transmission Through Walls; Complete Air Conditioning Systems; Estimating Requirements for the Home, Small Store, Restaurant; Layout of Duct Systems; Starting Up a System; Operating and Servicing Air Conditioning Systems; Air Filtration, Ventilating and Noise Eliminating Devices; Portable Electric Humidifiers and Room Coolers; Automatic Humidifiers; Air Conditioning Units for Radiator Systems and Warm Air Systems; Central Conditioning Units, etc.

**GERNSBACK PUBLICATIONS, INC.**

99 Hudson Street

New York, N. Y.

### MAIL COUPON TODAY!

GERNSBACK PUBLICATIONS Dept. RC-734  
99 Hudson Street, New York, N. Y.

Gentlemen: Enclosed you will find my remittance of Two Dollars for which you are to send me One Copy of the OFFICIAL AIR CONDITIONING SERVICE MANUAL, postage prepaid, as soon as it comes off the press. I am to pay the additional Two Dollars to postman when it is delivered. It is understood that the regular price of the book will be FIVE DOLLARS when it comes off the press, and I am now paying only a pre-publication price of Four Dollars.

Name \_\_\_\_\_

Address \_\_\_\_\_

City \_\_\_\_\_ State \_\_\_\_\_

(Send remittance in form of check, money order or unused U.S. Postage Stamps. Register letter if it contains stamps or currency.)



# LEARN RADIO IN 10 WEEKS!

## **PAY** FOR YOUR TRAINING AFTER YOU GRADUATE

I am making an offer that no other school has dared to do. I'll take you here in my shops and give you this training and you pay your tuition after you have graduated. Two months after you complete my course you make your first payment, and then you have ten months to complete your payments. There are no strings to this offer. I know a lot of honest fellows haven't got a lot of money these days, but still want to prepare themselves for a real job so they won't have to worry about hard times or lay offs.

I've got enough confidence in these fellows and in my training to give them the training they need and pay me back after they have their training.

If you who read this advertisement are really interested in your future here is the chance of a life time. Mail the coupon today and I'll give you all the facts.

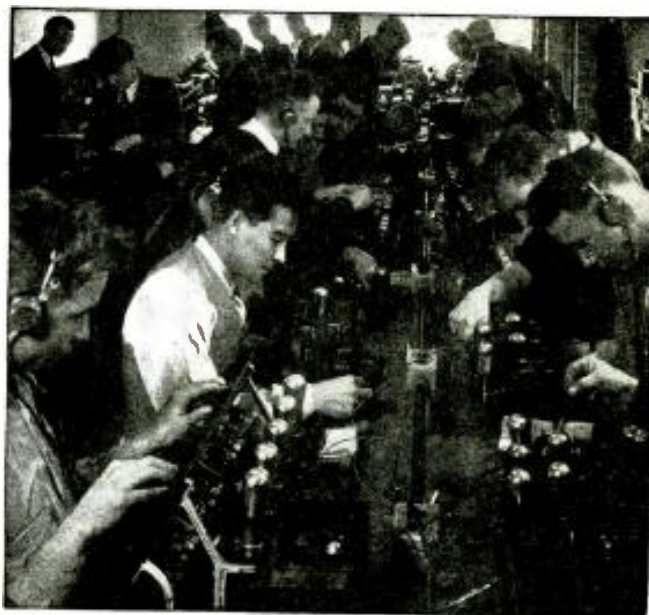

*A scene in the big, busy Radio Shops at Coyne. Here you see fellows working on real Radios—not reading about them from books or lessons. This is THE way to prepare for the big-money field of Radio!*

## TELEVISION *and* TALKING PICTURES

Television is already here! Soon there'll be a demand for THOUSANDS of TELEVISION EXPERTS! The man who learns Television now can have a great future in this great new field. Get in on the ground-floor of this amazing new Radio development! Come to COYNE and learn Television on the very latest, newest Television equipment. Talking Picture and Public Address Systems offer opportunities to the Trained Radio Man. Here is a great new Radio field just beginning to grow! Prepare NOW for these wonderful opportunities! Learn Radio Sound Work at Coyne on actual Talking Picture and Sound Reproduction equipment.

### PREPARE NOW and be ready for Radio's many opportunities

Forget pay-cuts—lay-offs—unemployment! Don't be tied down to an untrained man's future. You NEED TRAINING IN A FAST-GROWING MONEY-MAKING TRADE. Here's your chance of a lifetime to get it! Hundreds of opportunities now open in Radio. My sensational offer, explained below, makes it possible for you to START AT ONCE!

The right way to learn Radio is the Coyne way—not by books, but by actual, practical work on actual Radio, Television and Sound equipment. Here at Coyne you'll service and operate scores of modern Radio receivers, huge Broadcasting equipment, late type Television apparatus, Talking Picture machines, Code transmitters and receivers, etc. In 10 weeks you can step into a REAL JOB, leading to a salary of \$50 a week and UP!

### ALL PRACTICAL WORK At COYNE in Chicago

ALL ACTUAL, PRACTICAL WORK. You build radio sets, install and service them. You actually operate great Broadcasting equipment. You construct Television Receiving Sets and actually transmit your own Television programs over our modern Television equipment. You work on real Talking Picture

machines and Sound equipment. You learn Wireless Operating on actual Code Practice apparatus. We don't waste time on useless theory. We give you the practical training you'll need—in 10 short, pleasant weeks.

### MANY EARN WHILE LEARNING

You get Free Employment Service for Life. And don't let lack of money stop you. Many of our students make all or a good part of their living expenses while going to school and if you should need this help just write to me. Coyne is 33 years old. Coyne Training is tested—proven beyond all doubt. You can find out everything absolutely free. Just mail coupon for my big free book!

**H. C. LEWIS, Pres. RADIO DIVISION Founded 1899**  
**COYNE ELECTRICAL SCHOOL**  
**500 S. Paulina St., Dept. 4B-8H Chicago, Ill.**

### Mail Coupon Today for All the Facts

**H. C. LEWIS, President**  
**Radio Division, Coyne Electrical School**  
**500 S. Paulina St., Dept. 4B-8H Chicago, Ill.**

Dear Mr. Lewis: Send me your big FREE Book; details of your FREE Employment Service; and tell me all about your special offer of allowing me to pay for training on easy monthly terms after graduation.

Name.....  
Address.....  
City.....State.....



HUGO GERNSBACK, Editor-in-Chief  
 J. T. BERNSLEY, Managing Editor  
 C. W. PALMER Associate Editor  
 R. D. WASHBURNE Technical Editor



## CONTENTS OF THE JULY, 1934, ISSUE

VOLUME VI

Number 1

Editorial: Radio and the Sun.....	Hugo Gernsback	5
The Radio Month in Review.....		6
Radio Pictorial .....		8
The Latest Radio Equipment.....		10
Radio Device Guides the Blind.....	A. Halbran	12
The Radio Pen.....	C. W. Palmer	13
Flying "Blind" by Radio.....	Henry W. Roberts	14
International Radio Review .....		16
A Radio-Controlled Boat.....	R. H. Packard	18
A Set Sensitivity Tester.....	J. T. Bernsley	19
Important Facts About the New All-Wave Antenna Systems (Part I).....	R. D. Washburne	20
<b>AUTOMOTIVE RADIO DATA:</b>		
New Auto-Radio Sets and Features.....		22
Auto-Radio Installation and Service Hints.....		24
New Auto-Radio Remote Control.....		25
New Auto-Radio Set Diagrams.....		26
A 3 Tube A.C. Short-Wave Set.....	Frank Lester	28
A Practical Filter for All-Wave Receivers.....	A.D. Lodge	28
Uplifting the Servicing Profession (Part II).....	F. E. Colt	29
Short-Cuts in Radio.....		30
Operating Notes .....		32
RADIO-CRAFT'S Information Bureau .....		33
<b>RADIO SERVICE DATA SHEETS:</b>		
No. 117—General Electric "Auto and Home" Model B-52 5 Tube Superheterodyne.....		34
No. 118—Useful Automotive-Radio Reference In- formation .....		36
Book Review .....		59

## IN OUR NEXT FEW ISSUES:

**CONVERTING OLD RECEIVERS.** A good many requests have been received from experimenters regarding the conversion of certain old, but still popular receivers, to incorporate improved tubes and circuits—for instance, screen-grid, pentode and multi-purpose tubes, and A.V.C. operation. In the forthcoming issue we will have pertinent, definite data and procedure of this type concerning some of the more widely-used, old-style sets. Service Men who are more versed in theory will find this information a considerable time-saver in that considerable calculation work is eliminated for them.

**5 TUBE PORTABLE.** Portable receivers are in wide demand at this time of the year. And not only are they handy around vacation time, but they can be counted on to perform all year 'round in rural districts when line-power supply is generally unavailable. A small and efficient 5 tube set, all self-contained, will be illustrated and described in complete detail, in an interesting article to appear in the forthcoming issue.

RADIO-CRAFT is published monthly, on the fifth of the month preceding that of date; its subscription price is \$2.50 per year. (In Canada and foreign countries, \$3.00 a year to cover additional postage.) Entered at the post office at Mt. Morris, Ill., as second-class matter under the act of March 3, 1879.

Text and illustrations of this magazine are copyright and must not be reproduced without permission of the copyright owners. We are also agents for WONDER STORIES and EVERYDAY SCIENCE AND MECHANICS. Subscription to these magazines may be taken in combination with RADIO-CRAFT at reduced Club rates. Write for information.

Copyright 1934. Continental Publications, Inc.

HUGO GERNSBACK, President  
 I. S. MANHEIMER, Secretary  
 Published by Continental Publications, Inc. Publication office: 404 N. Wesley Ave., Mount Morris, Illinois. Editorial and Advertising Office: 99 Hudson Street, New York City. Chicago Advertising Office: L. F. McClure, 919 North Michigan Avenue, Chicago, Ill. Western Advertising Office: Loyd B. Chappell, 511 So. Alexandria St., Los Angeles, Calif.

London Agent: Hachette & Cie., 3 La Belle Sauvage, Ludgate Hill, E.C. 4  
 Paris Agent: Hachette & Cie., 111 Rue Reaumur  
 Australian Agent: McGills Agency  
 179 Elizabeth St., Melbourne



# I will Train You at Home



**Here's Proof**

in your spare time  
to fill a  
**GOOD JOB**  
in Radio

Get away from disagreeable jobs with no future. From skinny, little pay envelopes. From skipping along, just barely getting by, but not getting ahead. **DON'T PUT UP WITH THEM ANY LONGER.** Get into a field with a future. Get today to put yourself ahead. Mail the coupon for my free 64-page book that tells how you can train at home in your spare time to be a Radio Expert; about my Course that doubles and triples the pay of many who take it. **MAIL THAT COUPON NOW** and take the first step toward a real future.

**Free Book Tells How Mail Coupon!**



**Service Manager Earns \$200 Month**

"As Radio Service Manager for Sterchi's four Nashville Stores, my earnings are around \$200 a month. My N.R.I. training enables me to keep our customers satisfied."

E. H. Leftwich  
Sterchi Bros. Stores, Inc.,  
Nashville, Tenn.



**\$120 a Month in Spare Time**

"I'm servicing from 3 to 5 sets daily in spare time and average \$120 a month from my Radio work. I still hold my regular day job. I owe my success to N.R.I."

A. E. Farmer  
1012 Denison St.,  
Muskogee, Okla.



**Owes a Lot to N. R. I.**

"After finishing my tenth lesson, I started on my first job. After that, jobs came rolling in and I found myself with a surplus of money with which to continue paying for my Course. My first year's record was 108 Radio Jobs. I have cleared \$2,305 to date in spare time."

John Hearl  
66-53 Jary Ave.,  
Maspeth, L. I., N. Y.

## Real Opportunities Ahead in Radio for Trained Men

It's hard to find a field with more opportunity awaiting the trained man. Why in 1933, one of the worst depression years the Radio Industry sold \$213,000,000 worth of sets and parts! Radio set sales increased 45%—tube sales increased 25%. Over 300,000 people worked in the industry. It's a gigantic business, even in the worst business years. And look what's ahead! Millions of sets are becoming obsolete annually. 16,000,000 sets are in operation on which over \$200,000,000 are spent each year for repairs, servicing, new tubes, etc. Broadcasting stations pay their employees (exclusive of artists) approximately \$23,000,000 a year. Advertisers pay 600 great broadcasting stations over \$75,000,000 a year for radio time and talent. These figures are so big that they're hard to grasp! Yet they're all true! Here is a new industry that has grown to a commercial giant! No wonder great business leaders predict a brilliant future for this great and growing business!

## Get Into This Field With a Future

There's opportunity for you in Radio. Its future is certain. Television, short wave, police Radio, automobile Radio, loud speaker systems, aircraft Radio—in every branch, developments and improvements are taking place. Here is a real future for thousands and thousands of men who really know Radio. Get the training that opens the road to good pay, and success! Send me the coupon now, and get full particulars on how easy and interesting I make learning at home. Read the letters from graduates who are today earning real money in this fascinating industry.

## Many Make \$5, \$10, \$15 a Week Extra in Spare Time Almost at Once

My book also tells how many of my students made \$5, \$10, \$15 a week extra in spare time, soon after they enrolled. I give you plans and ideas that have made good spare time money—\$200 to \$1,000 a year—for hundreds of fellows. My Course is famous as "the one that pays for itself."

## Money Back if Not Satisfied

I am so sure that N.R.I. can train you satisfactorily that I will agree in writing to refund every penny of your tuition if you are not satisfied with my Lesson and Instruction Service upon completion. You'll get a copy of this Agreement with my book.

## 64-page Book of Information Free

Get your copy today. It's free to any ambitious fellow over 15 years old. It tells you about Radio's spare time and full time job opportunities; it tells you all about my Course; what others who have taken it are doing and making. Find out what Radio offers YOU without the slightest obligation. **MAIL THE COUPON** in an envelope, or paste it on a 1c post card NOW.

**J. E. SMITH, President**  
National Radio Institute, Dept. 4GX  
Washington, D. C.



## SPECIAL Radio Equipment for Broad Practical Experience Given Without Extra Charge

My Course is not all theory. I'll show you how to use my special Radio equipment for conducting experiments and building circuits which illustrate important principles used in such well-known sets as Westinghouse, General Electric, Philco, R. C. A., Victor, Majestic, and others. You work out with your own hands many of the things you read in our lesson books. This 50-50 method of training makes learning at home easy, interesting, fascinating, intensely practical. You learn how sets work, why they work, and how to make them work when they are out of order.

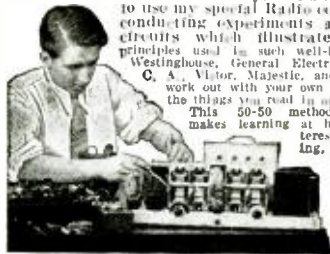

## SPECIAL FREE OFFER



Act now and receive in addition to my big free book, "Rich Rewards in Radio," this Service Manual on D.C. A.C., and Battery operated sets. Only my students could have this book in the past. Now readers of this magazine who mail the coupon will receive it free. Overcoming hum, noises of all kinds, fading signals, broad tuning, hums and oscillations, poor distance reception, distorted or muffled signals, poor Audio and Radio Frequency amplification and other vital information is contained in it. Get a free copy by mailing the coupon below.

**I have doubled and tripled the salaries of many. Find out about this tested way to BIGGER PAY**



**FILL OUT AND MAIL THIS COUPON TODAY**

J. E. SMITH, President  
National Radio Institute, Dept. 4GX  
Washington, D. C.

Dear Mr. Smith, I want to take advantage of your Special Offer. Send me your manual "Trouble Shooting in D.C., A.C., and Battery Sets" and your book "Rich Rewards in Radio," which explains Radio's Opportunities for bigger pay and your method of training men at home in spare time. I understand this request does not obligate me. (Please print plainly.)

Name \_\_\_\_\_ Age \_\_\_\_\_  
Address \_\_\_\_\_  
City \_\_\_\_\_ State \_\_\_\_\_ M

**The Famous Course That Pays for Itself**

# Radio Men!

**GOOD BOOKS WHICH HELP  
MAKE RADIO WORK MORE PROFITABLE**

Presented on this page are books of the RADIO-CRAFT LIBRARY SERIES—a most complete and authentic set of volumes treating individually, important divisions of radio. Each book has been designed to give radio men the opportunity to specialize in one or more of the popular branches of the industry. You will find them a real help in your work and they will contribute to your money earning capacity. Read these books during your spare time at home.

The authors of these books are well-known to everyone. Each is an expert radio man; an authority on the subject—each is thoroughly familiar with the field which he represents.

This is the first real opportunity that you have ever had to build a library of radio books that are authentic. **MOST OF THE BOOKS HAVE BEEN RECENTLY REVISED AND REWRITTEN TO KEEP THEM UP TO THE MINUTE.** Mail coupon below for your books.

Book No. 1  
**Radio Set Analyzers**  
And How To Use Them  
By L. VAN DER MEL  
With Full Instructions and Descriptions of Set Analyzers, Tube Checkers, Oscillators, etc. (Just revised.)

Book No. 2  
**Modern Vacuum Tubes**  
And How They Work  
By ROBERT HERTZBERG  
With complete Technical Data on All Standard and Many Special Tubes. (Just revised.)

Book No. 3  
**The Superheterodyne Book**  
All About Superheterodynes  
By CLYDE FITCH  
How They Work, How to Build and How to Service Them.

Book No. 4  
**Modern Radio Hook-Ups**  
The Best Radio Circuits  
By R. D. WASHBURNE  
A Complete Compendium of the Most Important Experimental and Custom-built Receivers.

Book No. 5  
**How to Become a Radio Service Man**  
By LOUIS MARTIN  
How to get started in the business of servicing radios and how to make money in this field.

Book No. 6  
**Bringing Electric Sets Up to Date**  
By CLIFFORD E. DENTON  
With Pentodes, Multi-Mus, Dynamic Speakers—Complete Information How to Modernize A. C., D. C. and Battery Operated Receivers.

Book No. 7  
**Radio Kinks and Wrinkles**  
By C. W. PALMER  
For Service Men and Experimenters  
A Complete Compendium on the Latest Radio Short-Cuts and Money Savers—These Kinks Are Great Time-Savers.

Book No. 8  
**Radio Questions and Answers**  
By R. D. WASHBURNE  
A Selection of the Most Important of 5,000 Questions Submitted by Radio Men During the Course of One Year—They Are All Answered by a Technical Expert.

Book No. 9  
**Automobile Radio and Servicing**  
By LOUIS MARTIN  
A Complete Treatise on the Subject Covering All Phases from Installing to Servicing and Maintenance. A Book That is Greatly Needed Today. (Just Revised.)

Book No. 10  
**Home Recording and All About It**  
By GEORGE J. SALIBA  
A Complete Treatise on Instantaneous Recordings, Microphones, Recorders, Amplifiers, Commercial Machines, Servicing, etc.

Book No. 11  
**Point-to-Point Resistance Measurements**  
By CLIFFORD E. DENTON  
The Modern Method of Servicing Radio Receivers—a Book Which Radio Service Men Have Referred to More Than Any Other.

Book No. 12  
**Public Address Installation and Service**  
By J. T. BERNSELY  
Modern Methods of Servicing and Installing Public Address Equipment.

**Big Discount To You**

In order to make it possible for everyone to buy these books, the fifty (50) cent price has been made uniform for all volumes. You can buy these books separately, but you should take advantage of our special offer:

**When Five (5) Books Or More Are Ordered Deduct 20% From Your Remittance**

Simply fill in the coupon at left, and mail it to us together with your remittance. Checks, stamps or money orders accepted.

**Here are the subjects covered--**

- Set Analyzers
- Tubes
- Superheterodyne Circuits
- Radio Hook-ups
- Servicing Business
- Modernizing Electric Sets
- Kinks and Wrinkles
- Questions and Answers
- Auto-Radio Servicing
- Home Recording
- Resistance Measurements
- Public Address

**All Books Uniform** Volumes are all uniform size, 6 x 9 inches, and contain on an average of 50 to 120 illustrations. Each book is printed on fine paper and no expense has been spared to make it an outstanding value.



**CLIP—MAIL THIS COUPON TODAY!**

GERNSBACK PUBLICATIONS, INC., 99 Hudson Street, New York, N. Y.

I have circled below the numbers of books in the RADIO-CRAFT LIBRARY SERIES which you are to send me, and have deducted 20% for ordering five (5) books or more. I have included my remittance in full, at the price of 50c each, when less than five books are ordered.

The amount of my remittance is.....(Stamps, checks or money orders accepted.)

Circle numbers wanted: 1 2 3 4 5 6 7 8 9 10 11 12

Name ..... Address .....

City ..... State ..... RC-734





"Takes the Resistance Out of Radio"

Editorial Offices: 99 Hudson Street, New York, N. Y.

HUGO GERNSBACK, Editor

Vol. VI., No. 1, July, 1934

# RADIO AND THE SUN

An Editorial by HUGO GERNSBACK

**W**HEN the ancients were worshipping the sun, they knew what they were about. Our present good-natured tolerance of past and present sun-worshippers might be a little more serious if all the facts were known. As a matter of fact, our entire world and everything that goes with it—humanity included—is absolutely dependent upon the sun. If the sun should cease to give out radiant energy which, in popular parlance, means light and heat, our planet would become a dead and barren world in a few generations, with every living thing exterminated at the end of a few hundred years, at the most, except those in subterranean caverns, where there could still be maintained a sufficient degree of heat for a little time to come.

Radio too, in a way, is dependent upon the sun, and the radio engineer of today must cope with various problems that are created by different solar radiations. Thus, the Heaviside Layer, an "ionized" invisible film that surrounds our planet some sixty miles up, is due directly to solar radiation. The sun constantly bombards our earth with most powerful electronic discharges, which create various electrical effects not only in our atmosphere, but in the earth itself.

At the present time we are on the rising curve of the so-called eleven-year sunspot cycle. Last month, one of the largest sunspots in recent years has been observed; this particular spot measures some 17,000 miles in diameter, and is a vast hole in the sun's heated surface, large enough to hold four globes the size of our earth. These solar spots, which are vortices or whirlwinds of tremendous energy, bombard the earth with a titanic amount of electrical energy, which causes disturbances on our planet. These disturbances are set up in the earth's crust, as well as in the atmosphere, and give rise to so-called magnetic storms. In the atmosphere, the gigantic disturbances give rise to "static" interference, which affects every radio set, and makes the life of the radio engineer, in particular, more or less miserable because, as yet, we have no static eliminator. Nor will things get better during the next few years; for the sunspot cycle has its ups and downs, and we are just at the beginning of the upward swing. The solar disturbances will get worse during the next four or five years, reaching a peak probably about 1938 or 1939; after this, the solar storms will moderate and conditions will improve.

The last year or so, conditions, so far as radio static was concerned, were excellent, and we again had good DX reception, such as we used to have in 1922 and 1923. From now on, conditions should not be so good while solar disturbances are increasing.

This is the first sunspot cycle, since radio broadcasting started, when it has been possible to test out short-wave reception throughout the whole period. When broadcasting first started (that is in 1921) we had no short-wave reception worth talking about; but in the present cycle our engineers and research men, as well as radio fans, should be enabled to accumulate valuable data about the solar disturbances in their relation to short waves. It is well known that, at the height of sunspot activity, broadcast reception suffers; whether the same is the case with short-wave reception, we have, as yet, to learn. The reason we do not know is that the atmospheric medium or paths that make short-wave reception possible are totally different from those followed by the longer broadcast waves. The problem is closely tied up to the Heaviside and other atmospheric layers; and, since these are dependent upon solar radiation, we will no doubt learn more pertinent facts during the next few years. Much valuable data will be collected, and it is to be hoped that everyone will join in the study of the problem. Even short-wave listeners can give valuable information by plotting curves from day to day as to reception of certain distant stations. If, at the same time, they listen for static and note the rate of such disturbances, then, at the end of each year, every listener will have accumulated much valuable data that can be of great importance to the radio industry for years to come.

It is quite certain that, during the coming sunspot maximum, static will be unusually bad not only throughout the summers, but during the other seasons as well. During the past few years the static has not been very bad; and radio engineers devoted most of their efforts to creating signals powerful enough to over-ride static. At this particular time, it is to be hoped that radio research men in all parts of the world will tackle the static problem in earnest for its solution and, if static during the next few years gets really bad enough, you may rest assured that something will be attempted to rid radio of its old arch-enemy.

# THE RADIO MONTH



THE PALO ALTO STATION  
One of the powerful Mackay Radio inter-city radio telegraph stations—near San Francisco.

## INTER-CITY COMMERCIAL RADIO SERVICE

LAST month a situation that has been hanging fire for some time came to an abrupt climax. We refer to the rivalry between the International Telephone and Telegraph Corp. (also known as Mackay Radio) and the Radio Corp. of America for the establishment of a nation-wide inter-city radio communication network.

I. T. & T. has been working quietly for some time, obtaining licenses from time to time in the large cities. Last month two more were added making an even dozen — including Washington, D. C., Boston, New York, Chicago, New Orleans, San Francisco, Los Angeles, Seattle, Portland, Tacoma, Oakland and San Diego. Their service is similar to the line telegraph and in fact is handled through the Postal Telegraph offices. The advantage of radio service is in the speed with which messages can be sent over long distances, and in the reduced rates possible compared to regular telegraph service over these long distances.

At the same time, their rival, RCA, has not been asleep on the job but has just announced the inauguration of a similar inter-city radio telegraph service, and to date they have set up communicating equipment between Boston, New York, Washington and San Francisco, with a promise that before June first, Chicago and New Orleans will be added to the system. This service is handled through the Western Union offices, as well as the RCA offices.

The RCA however, have an ace card up their sleeve in the fact that they are installing "multiplex" transmitters. This simply means that three different messages can be sent at one time on one wavelength. As each circuit has a capacity of 60 words per minute, the total capacity of each wavelength allotted to the radio telegraph service is 180 words per minute.

There is no doubt that a large field is open in the transmission of telegraph messages between cities over the radio waves—and it seems that the old rivalry between Western Union and Postal Telegraph is bursting forth with new fire.

a cost of almost \$500,000 and since it has an output rated at 500,000 watts, the cost per watt obviously is \$1.00. More than 5 years elapsed between the time the station was originally started until the design and construction were completed. During the tests, verifications of reception were received from all parts of the world. And the original fears that the tremendous power would blanket all other transmission for miles around the station have since proven to be groundless.

## EXPORT OF U.S. RADIOS UP 138%

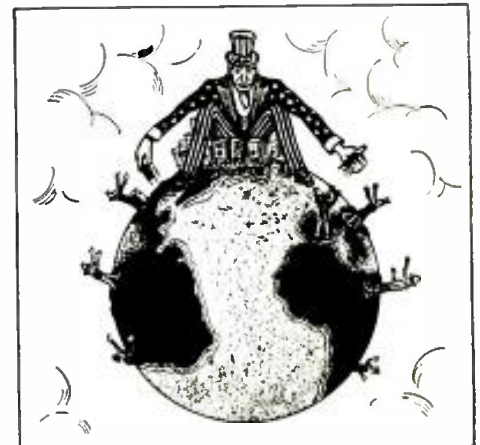

WITH EXPORTS UP 138%  
Uncle Sam is fast regaining his former position in the world radio trade.

## WLW ON THE AIR FULL TIME

ALTHOUGH the facts and construction of the new (but temporarily licensed) WLW giant transmitter were presented to RADIO-CRAFT readers several months ago, one day early last month the Federal Radio Commission granted a regular license for constant operation of this 500 kw. station. It was started up with all due formality by President Roosevelt who touched a small electric button, in Washington. Then for six hours without stop, the formal dedication continued, presenting some of the best talent that radio has produced.

It will be remembered by the readers of the first article that this new "super-power" broadcast station was built at

500,000 WATTS  
The appearance of the largest radio broadcasting station in the United States.

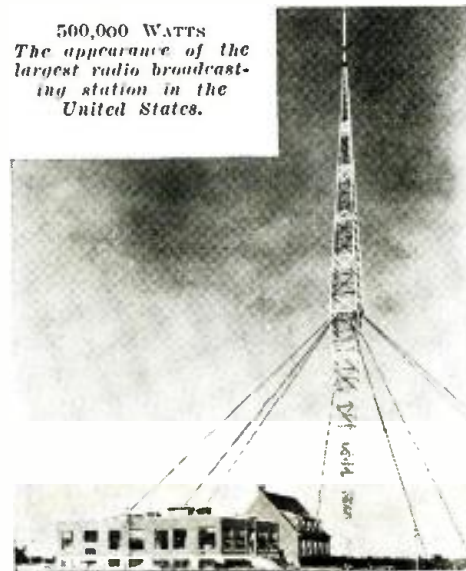

AS an indication that radio is contributing to-wards and prof-iting by, the general up-swing in business conditions comes a report fresh from the pens of the statisticians of the government.

In the latest month for which figures are available (in 1934), exports of radio sets from the United States amounted to a total of 56,335 as compared with 23,681 for the same month in 1933. This represents the remarkable increase of 138%.

	Month in 1934	Month in 1933
Spain .....	22,085	4,450
Mexico .....	4,284	2,797
South Africa .....	4,168	488
France .....	3,443	1,600
Brazil .....	2,442	2,145
Belgium .....	1,922	2,724
China .....	1,566	547



# IN REVIEW

Radio is now such a vast and diversified art it becomes necessary to make a general survey of important monthly developments. RADIO-CRAFT analyzes these developments and presents a review of those items which interest all.

United Kingdom ..	1,344	209
Argentina .....	1,124	108
Portugal .....	1,090	480
Egypt .....	1,086	404
Chile .....	895	19
New Zealand .....	841	1,041
Cuba .....	798	66

It is interesting to note that the largest purchaser of American sets is Spain—in the month referred to, they took all but 1,596 as many sets as we exported to the entire world during the same month of 1933.

## RADIOVOTA EXPERIMENT PROVES PRACTICAL



THE RADIOVOTA

We wonder how many cases of this type will be seen when the Radiovota is widely used!

In the June 1934 issue of RADIO-CRAFT, on page 721, we announced a new invention which permits radio listeners to voice their opinion about matters pertinent to radio broadcasting.

When the invention was first announced, the inventor, Dr. Nevil Monroe Hopkins, was criticized by the press for having invented a white elephant that was not practical and in fact would not work.

Last month, however, Dr. Hopkins' voting machine was given several practical tests over station WOR in Newark, New Jersey. The radio listeners in the vicinity of Newark were asked to vote on several questions by the simple expedient of turning on a 50 watt electric

light bulb at the requested time. Although this is not nearly as satisfactory as the method proposed by Dr. Hopkins, it proved satisfactory, as a very definite change in the power consumption at the local power house was indicated.

## WHO PROFITS FROM BROADCASTING?

In last month's issue of EDUCATION BY RADIO (a folder published by the National Committee on Education by Radio) some very salient views concerning the broadcast situation in the U. S. were given. A few of these facts are reprinted here for the benefit of our readers.

"The National Broadcasting Company made a profit of \$1,300,000 in 1932 and \$400,000 in 1933, according to the testimony of its president, Merlin H. Aylesworth, before the House Committee on Merchant Marine, Radio and Fisheries. The Columbia Broadcasting System showed a profit of approximately \$700,000 for each of the same two years according to one of its vice-presidents, Henry A. Bellows.

"What a contrast these two American private companies which control all national broadcasting in the United States, offer in comparison with the British Broadcasting Corporation. The NBC and CBS receive licenses from the Federal Radio Commission enabling them to control the dissemination of ideas on a national scale; induce the American public to invest billions of dollars in receiving sets, tubes and ac-

cessories; use—without paying a single cent for rent—air channels, which now and forever should remain the property of the people.

"The American radio broadcasting practice which depends upon the free use of the people's air channels and receiving sets as the major portion of and most expensive elements in a gigantic sales organization, could be likened to permitting the free use of the White House for the operation of a peanut stand or a liquor store.

"British broadcasting went through the same growing pains that the American variety is now experiencing. Prior to the formation of the British Broadcasting Corp., the electrical manufacturers controlled broadcasting. The British found commercial control as unsatisfactory as we are now finding it."

The views outlined in this statement are decidedly interesting. However, the discussion is not so one sided as pictured above. All the facts are presented on American vs. British broadcasting, in the March, 1934, issue of RADIO-CRAFT.



RADIO ROOM AT HOTEL LEXINGTON  
This set-up does not look much like the receiver in your home—does it!

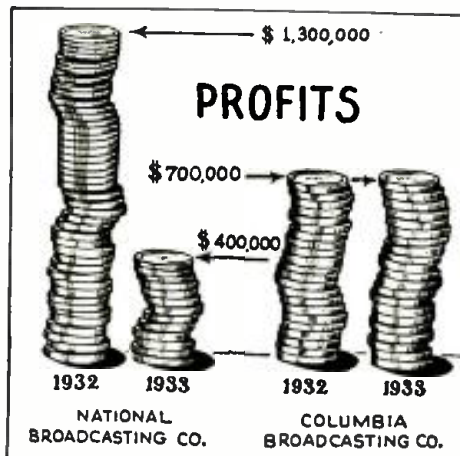

THE PROFITS OF BROADCASTING  
Even through the depression, NBC and CBS showed a handsome profit.

## MODERN HOTELS TAKE UP RADIO

One day last month, the guests at the Hotel Lexington, in little old New York were pleasantly surprised to learn that a complete centralized radio installation had been installed. So quietly and efficiently had the work been performed that few of the guests were even aware that the 280,000 feet of cable, 830 reproducers and four complete receivers and amplifiers had been put in.

The installation, one of the most extensive to be placed in an existing  
(Continued on page 51)



# —RADIO PICTORIAL—

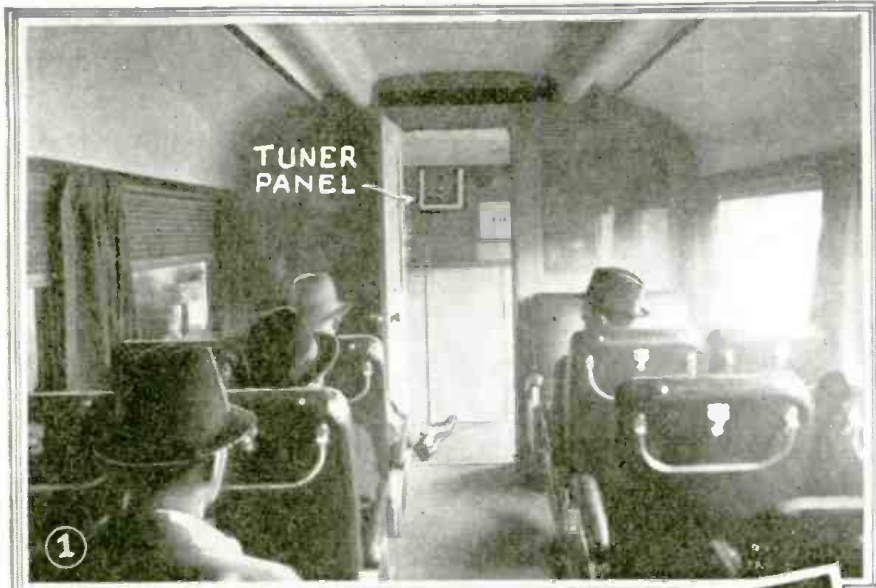

That much publicized streamlined, stainless steel train—the Zephyr—of the Chicago, Burlington & Quincy Railroad, which has begun its exhibition in the large cities of the United States is completely equipped with a radio receiving installation. This is the first permanent radio installation made in a train. As shown in Figs. 1, 2 and 3, the receiver is located on the platform of one of the sections of the train, while the reproducers are installed at the ends of the cars, concealed by decorative grilles. The aerial for the receiving equipment is located on the top of the car.—See Fig. 2.

When the regular organ of a church in Coventry, England, broke down the resourceful Vicar had a small harmonium, a 5 tube amplifier and two dynamic reproducers installed in the church so that the congregation would not miss the organ music. The results were so good that the Vicar claims that there is no longer any need for churches to install expensive organs. The installation is shown in Fig. 4.

At 5 is shown a new development that promises to be a boon to blind people. It is a phonograph recording which lasts the unusually long time of 3 hours for a complete record. Entire books on these records can be heard by blind persons with the aid of phonographs or electric pickups used with radio receivers. It is planned to place these records in libraries.

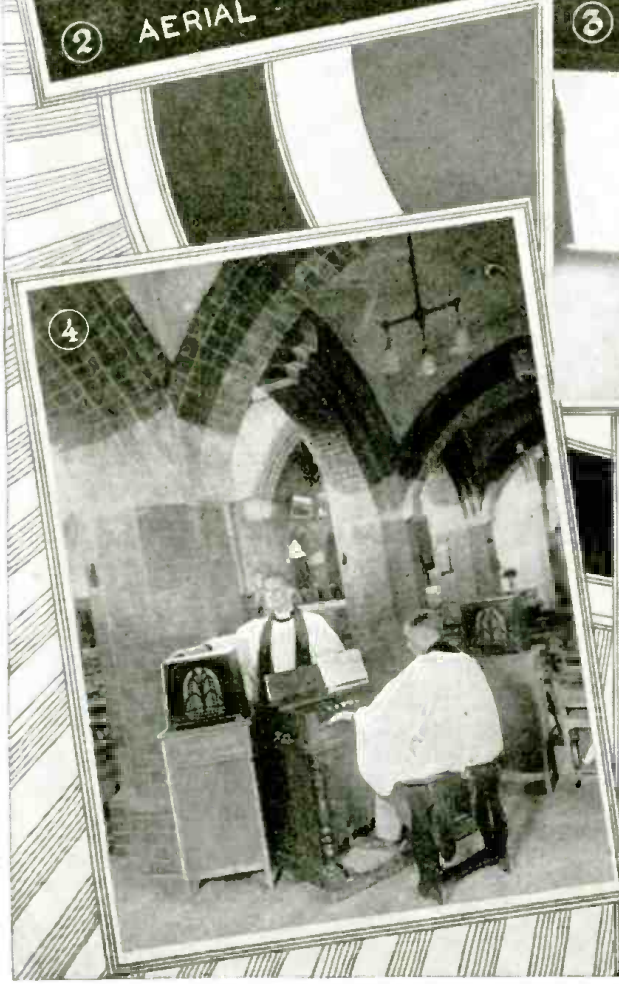
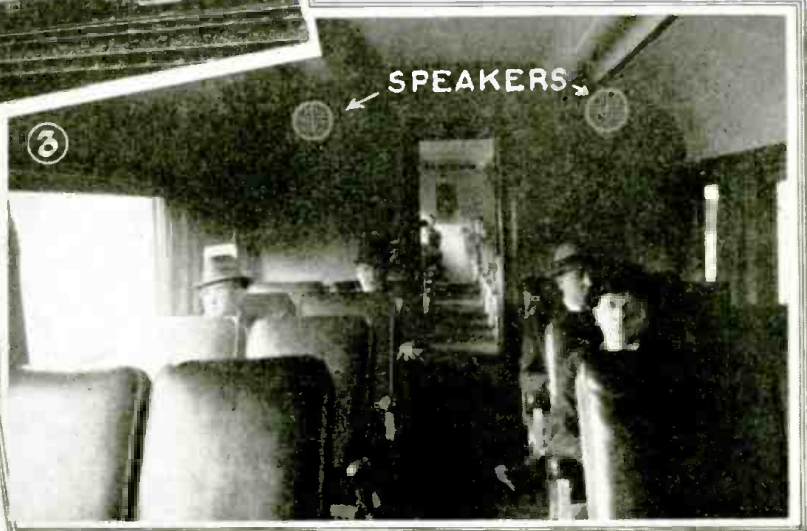
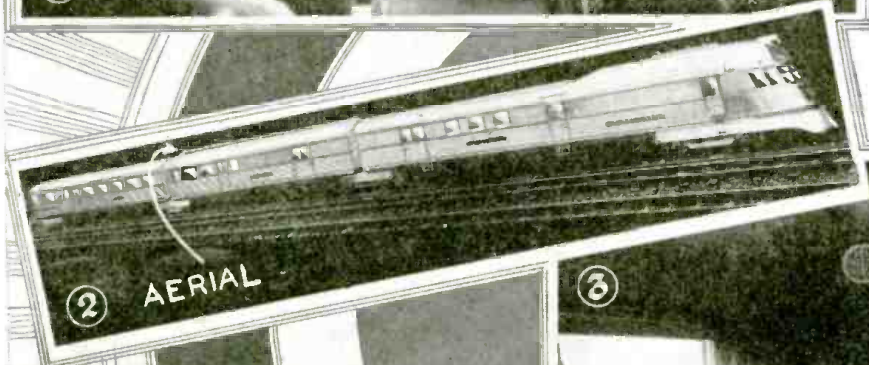



The applications of radio principles to surgery and medicine have been mentioned from time to time in RADIO-CRAFT. In radio's ever widening branches, is now included the healing of the sick. A specific example of equipment that makes this possible is shown in 6 and 7. Several years ago while working on a radio transmitter on very short wavelengths, engineers found that their body temperature was raised so that even though the actual temperature in the room was close to freezing, they became warm. This action was studied and subsequently it was found that the human body absorbed the energy from waves of a particular frequency. This action has been used in creating artificial fevers in the cure of certain molodies. At 6, high frequencies are used to actuate ultra-violet tubes which are inserted in ear, nose or other body openings where infection exists. At 7 is the artificial fever machine which utilizes spark gaps, rather than vacuum tubes for the generation of the high frequency currents which are applied to the body by capacity plates.

At 8 is shown a new device for locating the presence of radium or radio-active substances. It consists of a vacuum tube device, using a type 32 tube with a floating grid, which is located in the "feeler tube" and a type 30 tube as an amplifier. A visual indication of unbalance on the meter tells when radio-active substances are near the feeler tube.

The photographs at 9 and 10 show the equipment in the commentator's boat used in the classical Cambridge boat race. The radio equipment used on the launch is shown in Fig. 9 and the engineers and commentators are shown on the launch at 10. The transmitter works on short waves, which are picked up some distance from the scene of the race and transmitted by telephone line to "Broadcasting House" where they finally find their way out into the ether.

The photograph at 11 shows another way to make a P.A. system that can be easily transported to the scene of an event to be "sound equipped." This installation was made by a Pittsburgh, Pa. school.

Photo Courtesies: 1, 2, 3, Budd Mfg. Co.; 4, Globe Photo; 5, Press Photo; 6, 7, Lepel H. F. Labs; 8, Bureau of Standards; 9, 10, British Broadcasting Corp.; 11, Connelley Trade School.

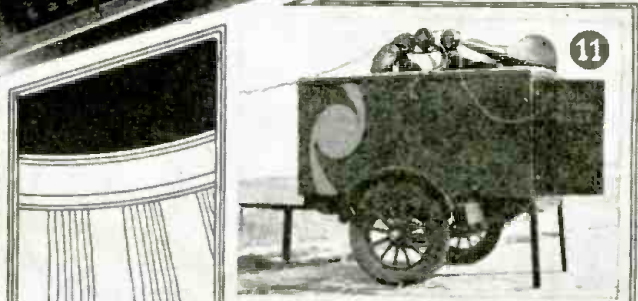
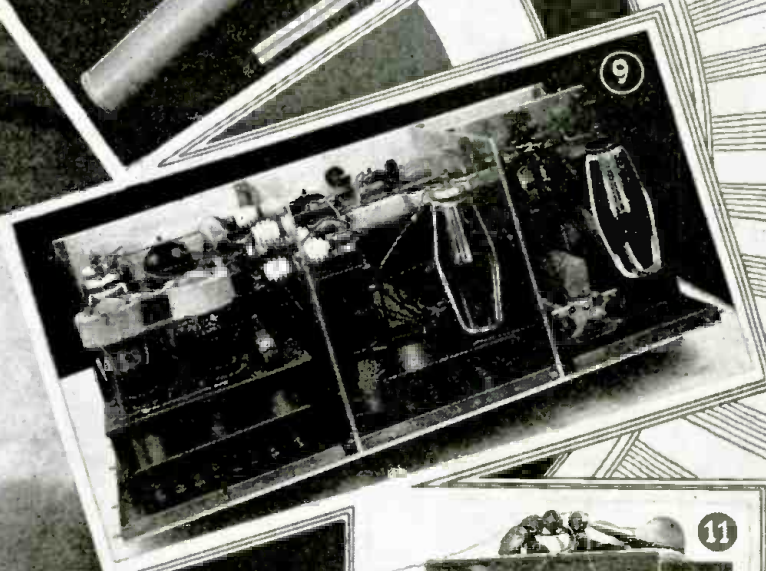
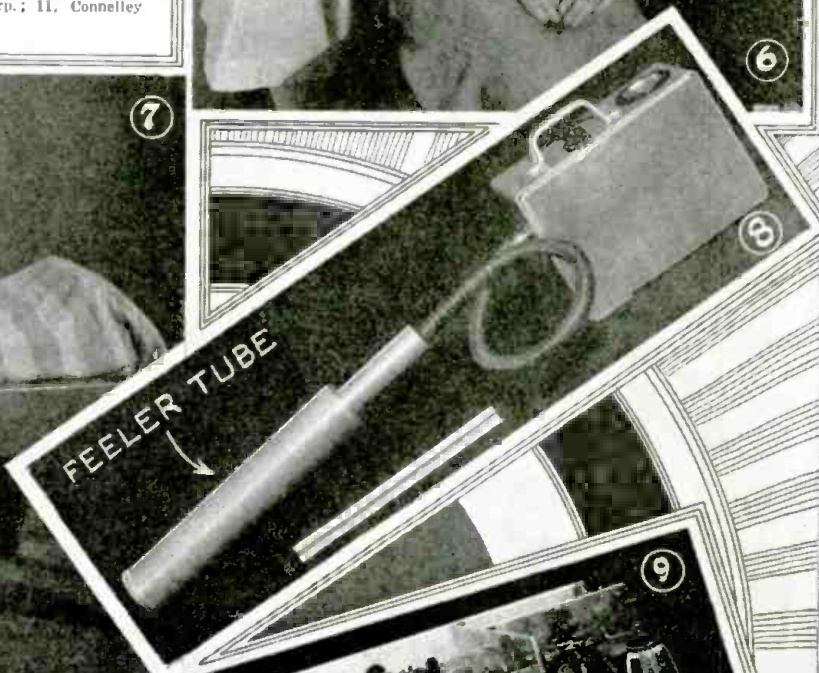



# THE LATEST RADIO EQUIPMENT



A portable "M.-G." (No. 466)

## PORTABLE MOTOR-GENERATOR (No. 466)

A 60 LB. unit with a constant output of 110 V., 350 W., 60 cy. A 2 cycle air-cooled single-cylinder gasoline motor, rope starting, drives a self-excited generator. The ignition system of the former unit is shielded, and the output of the latter is filtered, to prevent radio interference.

## A MULTI-TEST UNIT (No. 467)

A HIGH-QUALITY test instrument; the resistor tolerance is 1%; and the moving-coil instrument sensitivity is 2,000 ohms per volt. This instrument meets 4 major specifications. Ohmmeter range: ¼-ohm to 2 megs.; individual range: 0-2,000 (ohms)—0.2 (-meg.) -2 (megs.). (batteries, self-contained). Voltmeter range: 0-5-50-250-750 V. Milliammeter ranges: 0-5-50-250 ma. Micro-ampere range: 0-500. The automatic selector switch connects the meter only to the desired circuit and range.



Multi-test unit. (No. 467)



"Battery or A.C." set. (No. 468)

## THE "PORTETTE" (No. 468)

A 5 TUBE superheterodyne designed for portable operation on a 6 V. battery, or 110 V., A.C. Measures 7½ x 8 x 17½ ins. long; uses one, each, of the following tubes: 78, 6A7, 6B7, 41 and 1V. Total battery current consumption is less than 6A; on A.C., only 40W.



Crystal microphone. (No. 469)



All-wave coil switch. (No. 470)



Improved condenser mike. (No. 471)

## A "PIEZO-ASTATIC" ROCHELLE-SALT CRYSTAL MICROPHONE (No. 469)

DOES not require batteries or subsequent adjustment; feeds directly into high-impedance circuits, such as tube grids; and does not have any background noise. Case measures 1 x 3 ins. in dia. Response characteristic about 5 db., ±, from 20 to 6,000 cycles.

## A FLEXIBLE COIL-SELECTOR (No. 470)

A 4 COIL unit which permits any one of 4 coils to be connected into circuit. A distinct novelty lies in the fact that the coils are plug-in type and may be replaced by others having more desirable characteristics for operation in any type of circuit.

## IMPROVED CONDENSER MICROPHONE (No. 471)

THE unit illustrated comprises a condenser microphone and pre-amplifier. Improvements in back-plate design result in improved damping characteristics that level off the response curve. An air valve in the case compensates barometric differences.

## 11 TUBE ALL-WAVE RECEIVER (No. 472)

THE chassis of the receiver illustrated incorporates tone control and A.V.C. The upper frequency range is 5,500 to 15,500 kc. (54.5 to 19.3 meters, approx.); the lower, 540 to 1,700 kc. (555.2 to 176.4

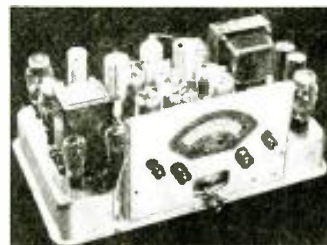

11 tube all-wave super. (No. 472)

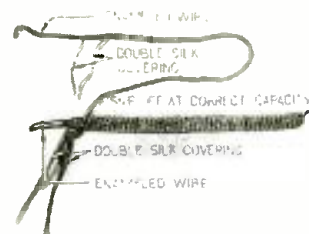

"Capacity" wire. (No. 473)



Improved condensers. (No. 474)

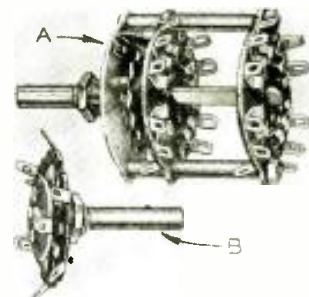

New coil switches. (No. 475)



A 220-110 V. adaptor. (No. 476)

Name of manufacturer of any device will be sent on receipt of a self-addressed, stamped envelope. Kindly give (number) in description under picture.



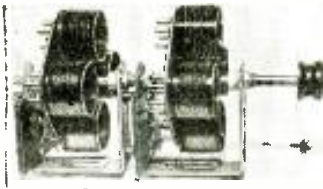

S-W. coil selector. (No. 477)

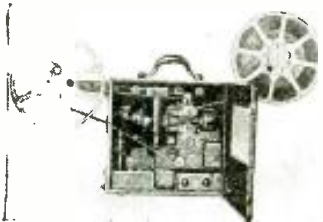

Portable talkies. (No. 478)



"B" vibrator. (No. 479)



"Wide range" amplifier. (No. 480)

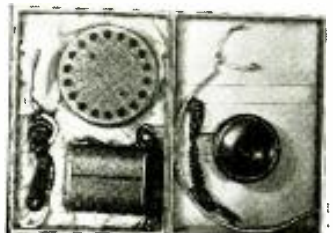

A new deaf set. (No. 481)



Dry-disc detector. (No. 482)

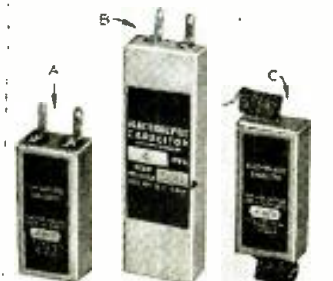

Small-space electrolytics. (No. 483)

meters, approx.). Uses a 2A7, 58, 2A6, 2A5, and an 80.

### "CAPACITY" WIRE (No. 473)

MERELY snip the wire at a point along its length that will result in securing the correct capacity value in experimental and commercial radio receiver circuits. This "capacity" wire, is made by winding double silk enameled wire of a small dimension around a heavier, double-silk-covered, enameled wire. It may be obtained in spools or in specified lengths, treated and measured for capacity.

### TUBULAR PAPER CONDENSERS (No. 474)

THE "pee-wee" types illustrated have tinned copper terminal strips which contact each foil of the condenser. These terminal strips are then soldered to tin metal washers to which the pigtails are soldered. This construction eliminates the condition of open or momentary contact that has been the main trouble in previous types. (If the pigtail breaks off a new lead may be soldered to the end washer.)

### SHORT- AND ALL-WAVE SWITCHES (No. 475)

AN improved all-wave switch is shown at A; at B, a short-wave switch. These single hole mounting switches are designed for low-resistance contact, noiseless operation and low capacity between circuits and the ground.

### 220 TO 110 V. STEP-DOWN AUTO-TRANSFORMER (No. 476)

NATIONAL and international requirements for a device that will permit 110 V., A.C. radio sets and associated equipment to be operated from a 220 V., A.C. supply are met by the auto-transformer shown in the figure. Standard capacity ratings, 125 and 250 W., on power line

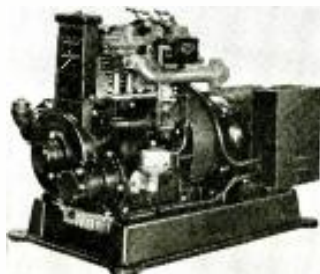

Electric plant. (No. 484)



Police dictaphone. (No. 485)

frequencies of 50 to 133 kc.; special sizes to order. Radio set plugs into unit which, in turn, plugs into power line.

### SHORT-WAVE COIL UNIT (No. 477)

ANY one of 4 coils connects into circuit by merely turning the control knob. Coil replacements are made by removing the central mounting screw. Provision is made for ganging units. The frame is adjustable to coil lengths.

### COMPACT 16 MM. TALKIE (No. 478)

TWO cases comprise this 16 mm. sound on film talkie. The amplifier and speaker are contained in one case and the projector equipment in the other. The amplifier is designed for operation on 110 V., A.C.; for operation on 110 V., D.C., a converter rated at 110 W. will be required. An A.C.-D.C. switch adapts the projector motor and lamp for universal operation.

### NEW "B" VIBRATORS (No. 479)

IMPROVEMENTS in vibrators for use in vibrator-type "B" units have resulted in the production of two designs (one of which is illustrated), referred to as the "full-wave," and "self-rectifying" types for use on 6 or 32 V. The former type utilizes a type 84 tube (minimum efficiency, 62%); the latter does not (minimum efficiency, 70%). A lead container houses the unit which, in turn, fits into a tin case lined with sponge rubber and fitted with a plug. Total weight of unit is 2 lbs.

### "WIDE RANGE" SOUND-FILM AMPLIFIER (No. 480)

THIS amplifier is entirely A.C. operated. Incorporates the following tubes: three 56's, two 2A5's and one 5Z3; power output, 10 W. Frequency response up to 10,000

(Continued on page 44)



Test unit selector set. (No. 486)

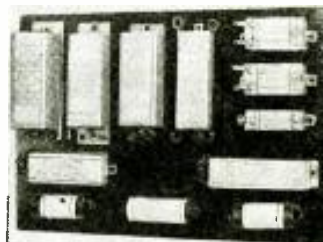

Replacement condensers. (No. 487)



Radio-phono., combined. (No. 488)

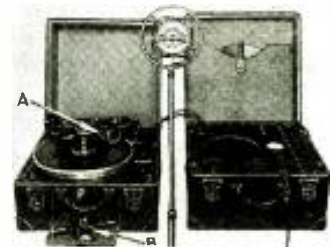

Improved sound recorder. (No. 489)

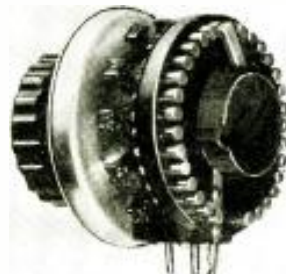

Small-space attenuator. (No. 490)



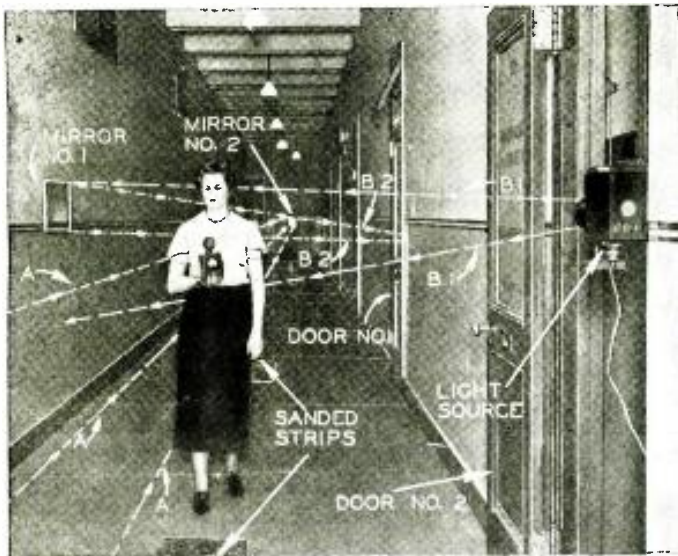

# RADIO DEVICE GUIDES THE BLIND

Electronic devices have found many uses in every day life. Here is another very practical application for the photoelectric cell—that of guiding blind people. Light beams, correctly located, form paths which are followed by the use of special photo-cell sound units.

A. HALBRAN



Fig. A  
Dotted lines A1, B1, C1 indicate light beam courses, and, A2, B2 and C2, reflections.

Fig. B  
The photoelectric guide unit, with its photonic cell on the top and a buzzer on the side.



**R**ADIO, in its ever widening branches, has included numerous humanitarian actions and devices—for example, the many rescues at sea and in flooded areas. And now another such service has been added to the list; not so glamorous as the two examples mentioned, yet not one iota less valuable to those poor unfortunates whom it aids.

We refer to the help that electronic devices are giving to blind people.

A unique system for guiding the blind by means of beams of light and a pick-up device held in the hands of the blind person has just been successfully demonstrated by its inventor, J. O. Kleber, at the American Foundation for the Blind. Completely dispensing with escorts, blind persons demonstrated their ability to find various offices, climb up and down stairs and traverse long halls aided only by beams of light projected from various locations and reflected by numerous mirrors. The principle of the system is the projection of a wide beam of light from a light source incorporated in which are optical lenses for controlling the intensity and width of the beam. A blind person is guided within the scope of the light beam; by means of a small portable unit attached to which is a photonic cell. The unit contains also a relay, flashlight battery

and a buzzer. This unit is held in the manner shown by the photographs on this page and on the cover. As the blind person travels along the light beam, the buzzer on the pick-up device is constantly sounding. If, however, the blind person should stray off the beam, the buzzer instantly ceases. Then the blind person stops, moves the unit around until he (or she) hears the buzzer, and continues.

The sources of these light beams are placed at strategic points in the various halls, stairways and offices and are so designed that they can be controlled by a central switchboard. Thus, if a blind person is in one office and desires to go to another office in the building, a switch is turned on which governs all the beams to that specific location. Other switches turn on the beams to other locations, etc.

For going around turns or corners a very interesting method is used. For, at intersections the light beams overlap, or rather cross one another and the blind person walking along the beam in one direction would not know when the other beam at a turn in the corridor was reached. To overcome this difficulty, sanded strips are placed on the floor at a point immediately in front of the point where the beams cross and the blind person knows, when this strip is reached, that it indicates a change in

(Continued on page 43)

Fig. C  
Interior of the stairway-beam device showing the photo cell and light source with the buzzer on top.

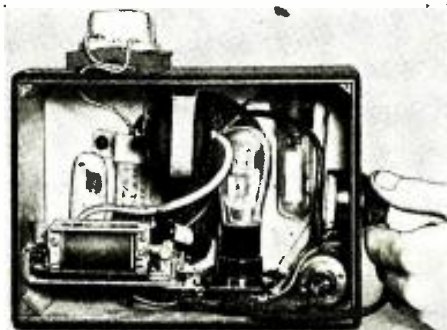

Fig. D  
The switching panel at the American Foundation for the Blind, for turning on the beams between different offices and rooms. An operator turns on the desired beams as needed.





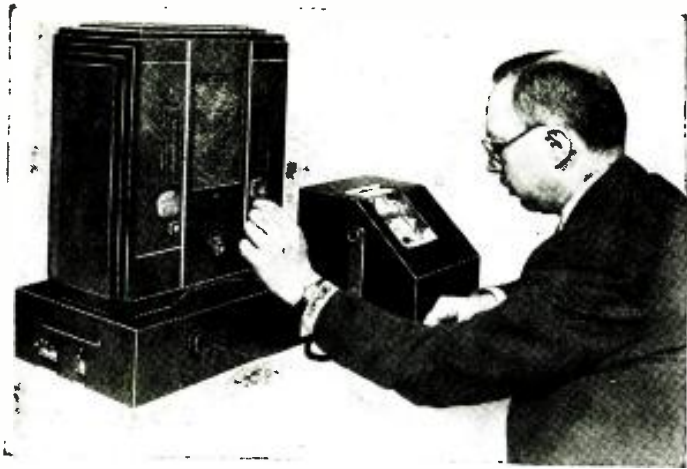

Fig. A  
John V. L. Hogan with his facsimile receiver.

# THE RADIO PEN

It is difficult to predict when television will become a reality. However, a device which satisfactorily approximates it, and which will have a novel use in the home, in connection with any receiver, has recently been satisfactorily demonstrated.

C. W. PALMER

TELEVISION, that most interesting subject for experiment, has received many setbacks during the past few years, the chief difficulties at present being financing and merchandising.

But even though we have been disappointed by the progress of television in its pure form, very definite steps have been made in allied lines. Take for example the radio typewriter, developed by a group of engineers, one of whom is Clyde Fitch, formerly connected with this magazine; and the radio ticker-tape invented by W. G. H. Finch—a man well known for his developments in the art of printing telegraph systems; or the radio "writing" systems, such as the hot air spray and similar systems developed by RCA in conjunction with Captain R. H. Ranger.

And now we have another system of radio "writing" that threatens to become even more popular than its predecessors—mainly because of its simplicity, low price and flexibility.

This is the "Radio Pen," an invention by John V. L. Hogan—well known for his patents covering ganging of condensers with a common shaft, and more popularly known as "single dial" tuning.

## How It Works

While this new facsimile transmission system is meant particularly for use in the home, in conjunction with the regular broadcast receiver, the engineers who have perfected it make no pretense that it will supplant the transmission of music and entertainment. Rather, it will aid the latter—with the ultimate aim of providing something similar to a radio newspaper (as explained by Hugo Gernsback in the April, 1934 issue of RADIO-CRAFT—"Radio Set Prints Newspaper").

The mechanics of the receiving equipment are quite simple. The entire instrument is contained in a small metal box about the size of a typewriter. It consists, essentially, of a motor which moves a pen swiftly back and forth across a strip of paper projecting from a large roll. The motor also moves the paper strip up line by line as the pen progresses. The pen is pulled to the surface of the paper by a magnetic device, actuated from a standard radio receiver (of the broadcast type). Impulses from the transmitter are picked up and rectified by the receiver and then actuate the magnetic device.

The motor is run from the 60 cycle power line, and in the demonstrations recently this was the only means used of synchronizing with the transmitter. In answer to a question by the writer, the inventor stated that synchronizing was not nearly as critical as that required for television, and in fact satisfactory results can be obtained by simply using a 60 cycle power line as a synchronizing means, even if the source of power for the transmitter and receiver are not the same. This of course is only true if the frequency of both power lines is kept at 60 cycles and does not shift considerably. According to the inventor there is no drifting of the "image" as in television.

Two types of transmitters have been devised for use with the Radio Pen. The early type required the use of motion-picture film containing the words or views to be transmitted. This transmitter is still used for announcements or other material which is repeated from time to time.

The later type has been arranged so that it will use pen-and-ink drawings, typewritten text or printed matter directly from the paper itself, thus eliminating the cost and delay of preliminary processing. This is the system used in making the abbreviated examples shown in Fig. 1.

The detail that is possible with this system of facsimile transmission is dependent upon the speed of transmission. For example, in the recent demonstration of the system (when the samples shown at Fig. 1, as well as a group of simple pictures of animals and other objects, were sent a distance of approximately 5 miles, from Long Island City

(Continued on page 39)

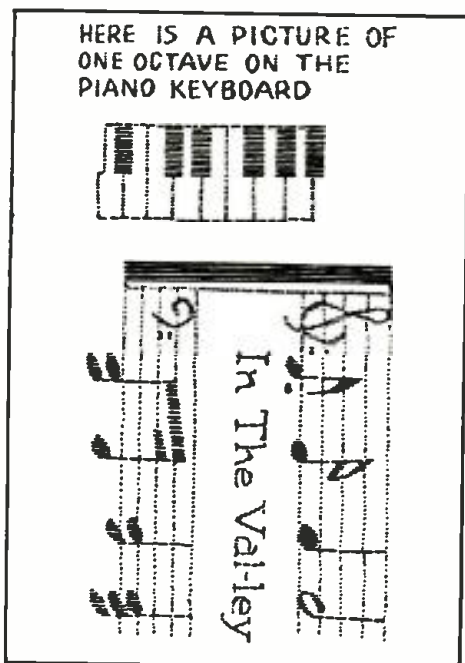

Fig. 1  
Several examples of the material transmitted.



Fig. B  
Pictures being sent on the special transmitter.

# FLYING "BLIND"



"Ceiling zero, visibility zero," radiophones the airport. With a radio beacon to guide him, the pilot securely wings his way. Radio warns him of weather ahead, brings him to his destination, and guides him to a safe landing.



United Air Lines photos

From coast to coast the air is throbbing with radio messages, guiding our airliners, unseeing and unseen, through fog and darkness.

Did you know that American air lines fly daily farther than six times around the world? Forty percent of their flying is done at night. Millions of miles are flown "blind" each year, for whatever the weather, the mail must go through, schedules must be maintained. This brilliant performance was made possible by extensive use of radio aids.

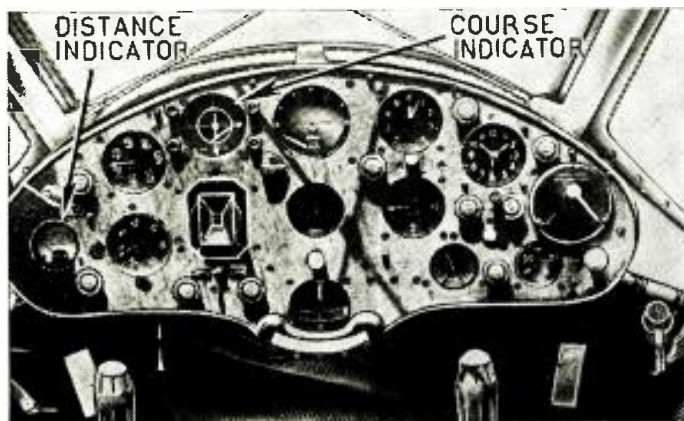

Blind landing requires only the two instruments shown above.  
U. S. Dept. of Commerce photo.

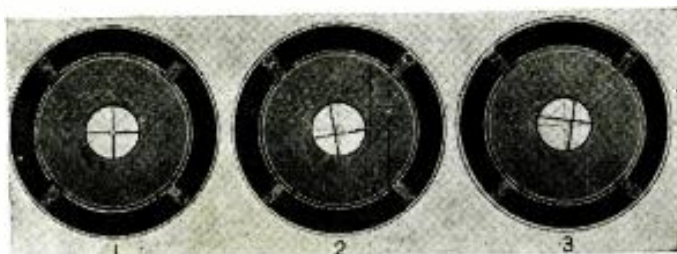

Both the direction of the airplane and its proper gliding path are shown on the instrument above. (1) on course; (2) too low and to the left; (3) too high and to the right.  
U. S. Dept. of Commerce photo.

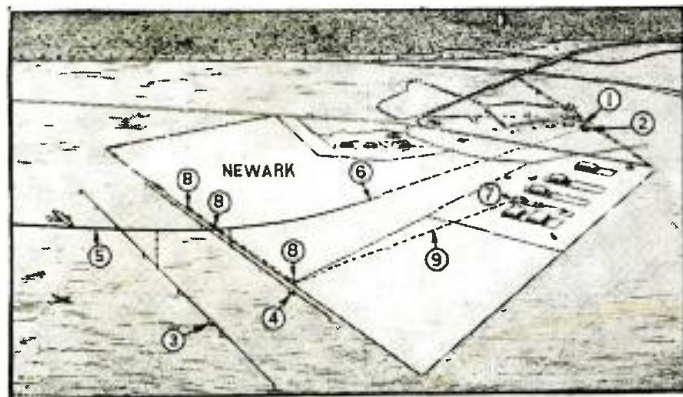

"ON INSTRUMENTS, on beacon, on course," drones the laconic message from an air liner somewhere in the clouds, steadily winging her way through fog to the home airport. And, one might add, "on schedule"—thanks to radio.

The extent to which commercial aviation depends on radio for maintaining its schedules regardless of weather is insufficiently appreciated by the general public. As a matter of fact, it is not an exaggeration to say that radio has made commercial aviation possible—because a transportation system is valuable to the public only in direct proportion to the regularity of its schedules, and radio is the only means of guiding aircraft unerringly through fog and darkness. Even the low-lying ground fog, that last enemy of schedules, was at last conquered by the ubiquitous radio.

While the mechanical process of "blind," or instrument flying does not rely on the aid of radio, the mere fact that the pilot is able to fly level and maneuver his ship without seeing the ground will not bring him to his destination, nor, indeed, even tell him where he is. From coast to coast stretches a mighty network of radio beacons, guiding aircraft on their rounds; from coast to coast invisible radio waves carry their terse messages, by voice and code, as the speeding ships talk to their airports. From leaving the ground until they land again, the pilots are in constant communication with the ground. The steady note in their ear-phones tells them that they are on course; periodically, on this same frequency, Federal weather stations cut in and broadcast their reports. A turn of the dial, and the pilot is in touch with the radio system of his own air line; every twenty minutes he reports his progress, receives instructions to change his altitude or course to avoid bad weather or pass in safety other airplanes which may also be flying blind on the same route. And when the destination is near, taxicab and hotel reservations are radiophoned to the terminal. Indeed, radio makes commercial aviation possible.

While it is possible to fly an airplane without a single instrument as long as the pilot can see the ground, safety in flight is obtained only through accurate knowledge of the functioning of all units of the complex piece of machinery comprising the modern air liner, and in prompt warning of any irregularity. For this reason, a number of instruments are carried, which can be divided into three groups; engine

Fig. 1—The Department of Commerce radio installation for blind landings, at Newark Airport. (1) short-wave landing beam station; (2) runway localizing beacon; (3) approach marker beacon; (4) boundary marker beacon; (5) spatial gliding path formed by constant field intensity below the inclined landing beam; (6) point of contact with the ground; (7) monitoring and two-way communication equipment; (8) remote control stations; (9) control cable.

U. S. Dept. of Commerce photo



# BY RADIO —

Radio daily accomplishes the seemingly impossible, guiding pilots through opaque nothingness to their invisible destinations.

On the New York General Post Office is carved an inscription: "Neither snow, nor rain, nor heat, nor gloom of nights stays these couriers from the swift completion of their appointed rounds." This story tells how radio helps our air lines to maintain this proud motto.

HENRY W. ROBERTS

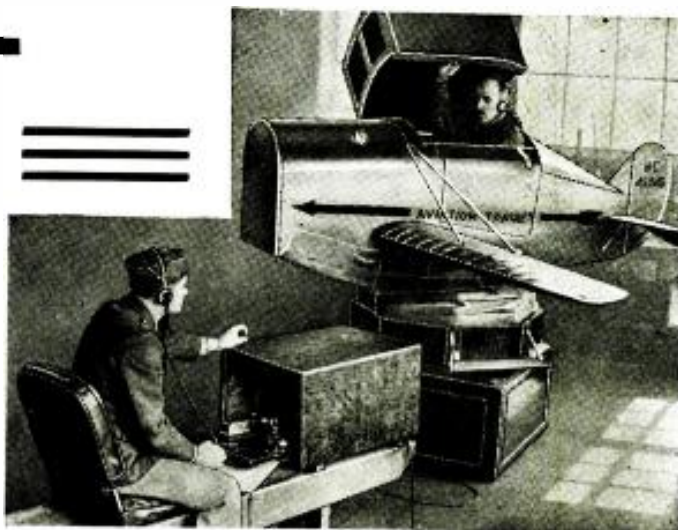

All conditions of blind flying can be simulated by this trainer. "Radio" signals are sent by the instructor at left. Casey Jones School photo.

group, flight group, and radio group. We are primarily concerned only with the third, or radio group, but a working knowledge of the flight instruments, and their limitations, is necessary for the proper understanding of the functions performed by the radio instruments.

### The Flight Instruments

The purpose of flight instruments is to permit maneuvering without seeing the ground, as ordinary senses do not function correctly without a point of reference outside the airplane; even the sense of gravity is lost, as centrifugal forces many times stronger than the earth's pull act on the pilot once the 200-mile-an-hour airplane gets out of control.

The most important blind flying instrument is the *artificial horizon*, consisting of a vertical axis gyroscope and a system of air jets and pendulum vanes, to correct for precession, which indicates the attitude of the airplane in relation to the surface of the earth. The *turn-and-bank indicator*, somewhat similar in principle, consists of a small gyroscope operating a vertical pointer, which indicates the amount and direction of turn; while the ball-and-tube level below the pointer shows if the airplane is correctly banked for the turn, centrifugal force keeping the ball at the bottom. The *rate of climb indicator* shows the true rate of ascent or descent irrespective of the attitude of the airplane in reference to the ground; the instrument consists of a sealed metal case with a capillary leak tube, within which is placed a sensitive diaphragm cell, connected with a pointer on the dial. As the airplane rises or descends, the pressure on the diaphragm changes instantly, while the pressure in-

(Continued on page 37)

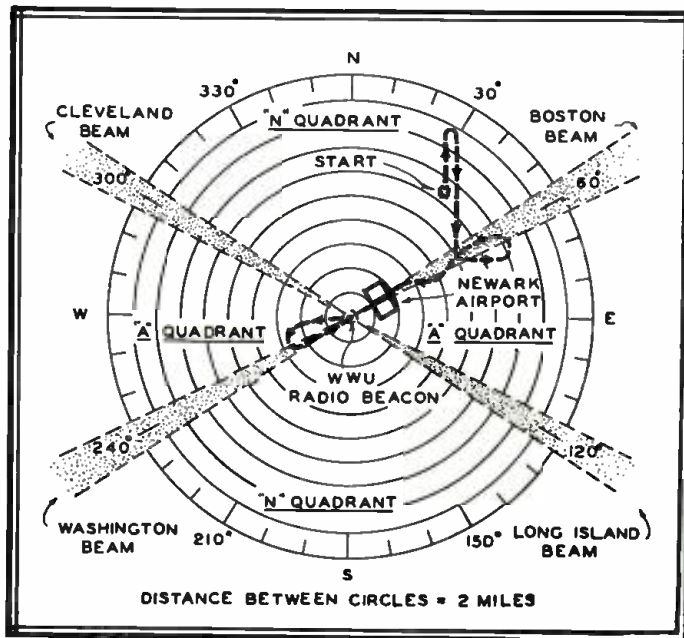
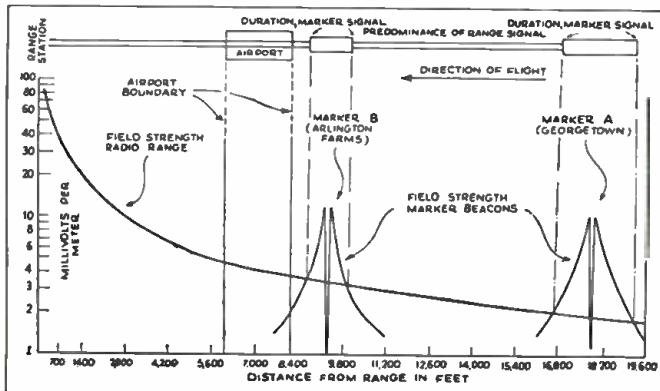
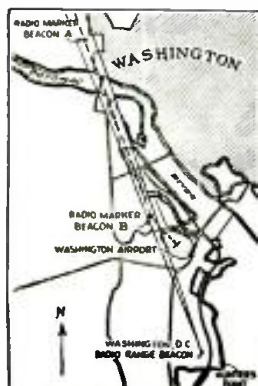

Fig. 2

A simplified diagram of a radio range beacon, and how a pilot finds the airport "blind." See text for details.

Fig. 3—Below.

At left, plan view of approaches to Washington airport, showing the radio range beacon and two marker beacons giving definite location to the pilot flying blind. At right, field intensity diagram of the arrangement, showing how the marker beacon signals are superimposed on the range beacon.



Below is a runway localizing antenna as developed by United Air Lines engineers.

United Air Lines photo

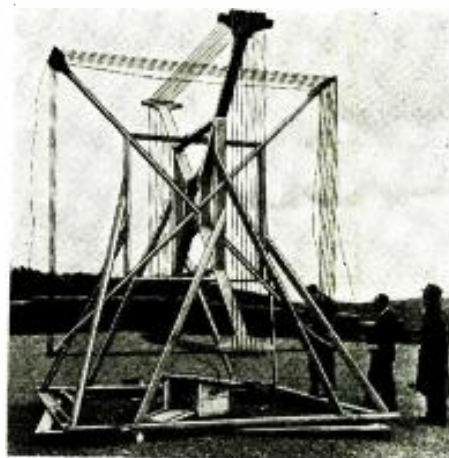

# INTERNATIONAL RADIO REVIEW



Fig. A

The new midget tube compared in size with a normal sized cigarette lighter.

## NEW ENGLISH MIDGET TUBES

IN an advance notice from the Marconi-Phone Company, Ltd., to RADIO-CRAFT, two new tubes just released on the English market were described.

These two tubes are identical in appearance, both being unusually small in size—only  $2\frac{3}{8}$  x 1 in. in diameter. They are both triodes, one having an amplification factor of 15 and a plate impedance of 30,000 ohms, and the other an amplification of 5 with a plate impedance of 12,500 ohms. The filament of both are the same, operating at 1 volt and consuming .1-ampere.

Another outstanding feature of these tubes is the base. As shown in Fig. A, there are no prongs on the bottom of the base—side contacts being substituted for the usual pins. This reduces the over-all size, increases the strength and in future multi-element types permits the use of more contacts than the pin construction. We predict that this type of base will find great favor and will ultimately be adopted by American tube makers.

The small size of these tubes, combined with their low filament and plate requirements makes them especially suitable for portable work; for portable receivers, deaf-aid amplifiers, police "personal" receivers, etc.

These tubes are constructed with a glass envelope, but a seal between the glass bulb and the base is of the same type of construction used in the Catkin tubes (RADIO-CRAFT, August, 1933, page 75).

## WIDE-FREQUENCY SPEAKER

RECENTLY, in radio engineering circles, all over the world, unusual interest has been given to the transmission and reception of high quality programs. For example, several months ago, we ran an excerpt from WIRELESS

HERE is what the radio experimenter has been wanting for a long time—a semi-technical review of the thousands of new ideas which are continually appearing in overseas publications. Each month there are received at the offices of RADIO-CRAFT hundreds of daily, weekly and monthly magazines originating from all over the world.

SINCE the cost of subscribing to each of these would be prohibitive for most radio men, we have arranged with technical translators to prepare for our readers reviews of all the really important, new developments illustrated and described each month in these publications.

NOTE that the only available information is that which is published; the experimenter must adapt the ideas to whatever equipment he has on hand.

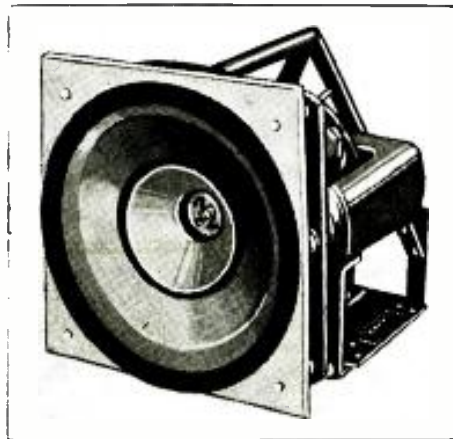

Fig. B, above; Fig. 1, below.  
The two-cone wide-frequency dynamic speaker.

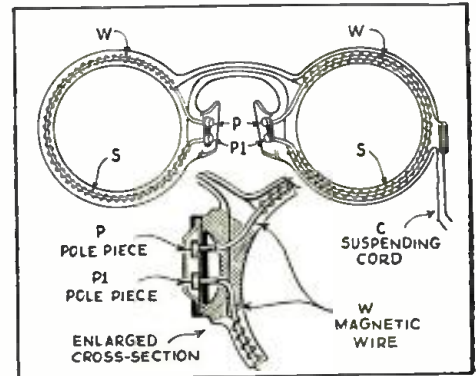
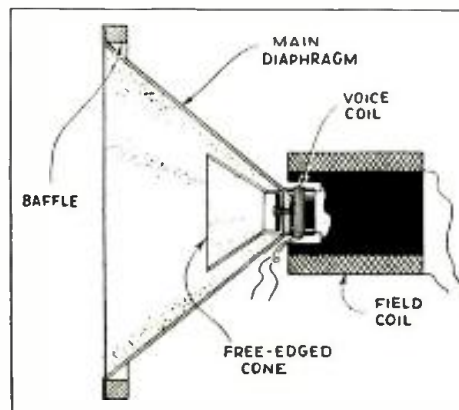

Fig. 2

This hearing aid is cleverly hidden in a pair of eye glasses. Note the windings.

WORLD describing a new dynamic speaker with a crimped voice coil to equalize the electrical and mechanical impedance so that the high frequencies would not be attenuated. With this reproducer, uniform response up to 10,000 cycles was claimed.

And then there were the much publicized experiments of the Bell Telephone Laboratories in "The Third Dimension in Music"—(RADIO-CRAFT, May, 1934, page 654).

Almost in step with our progress along these lines, the British have placed a new, and somewhat similar reproducer on the market. As shown in Figs. B and 1, this speaker has a subsidiary free-edged cone inside of the main diaphragm and mounted securely to the edge of the voice coil. The large diaphragm reproduces frequencies up to 4,000 cycles, and the small cone reproduces most frequencies above that frequency. The distribution at high frequencies is much wider with this type of construction than would be the case if the energy were radiated from the large diaphragm.

According to the description in WIRELESS WORLD, measurements show that the response is substantially flat from about 70 to 8,000 cycles, and that there is an appreciable response at 12,000 cycles.

This speaker combines in one unit the system suggested by the writer in the article "Twenty Ways to Improve Your Radio Set" in the April 1934 issue of RADIO-CRAFT, in which it was suggested that a separate speaker of the dynamic or piezo-electric variety, especially made for high frequencies could be added to an existing set to improve quality.

## NOVEL AID FOR THE DEAF

QUITE a few years ago, Hugo Gernsback invented a device to aid the near-deaf, which he called the "Osophone." This unit consisted simply of



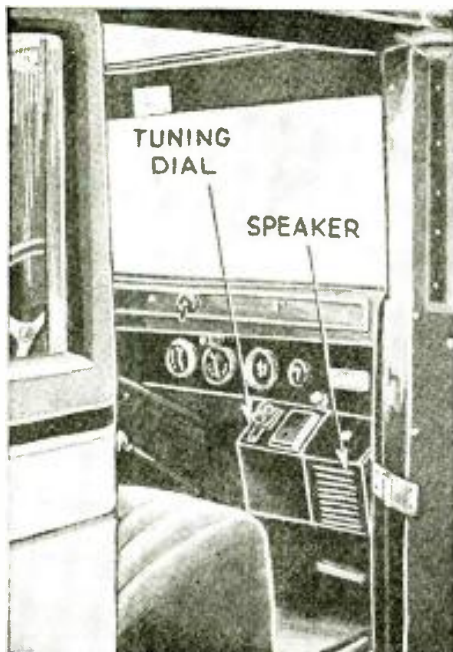

Fig. C  
A German version of how a car set should be made. It contains a "B" unit.

a phone, of unusual construction, the diaphragm of which was equipped with a bakelite piece that was gripped between the teeth. This device carried sound vibrations to the inner ear by bone conduction.

Since then, many bone conduction devices have been developed, some of which are in constant use by persons with defective hearing.

A recent issue of *AMATEUR WIRELESS* magazine contained a description of a novel type of bone conduction device. This is shown in Fig. 2. It consists of a pair of eye glasses, the rims of which are wound with a great many turns of fine wire over a soft iron core. The core ends in two flat pole-pieces, P and P1, which actuate thin diaphragms over the poles. These magnetic diaphragms, which also act as the nasal clamp of the glasses conduct the sounds to the bone at the bridge of the nose.

This is an ingenious way to conceal the hearing aid, as a suspension cord, C, can serve the double purpose of carrying current to the phones and at the same time act in the usual capacity as a supporting cord for the glasses.

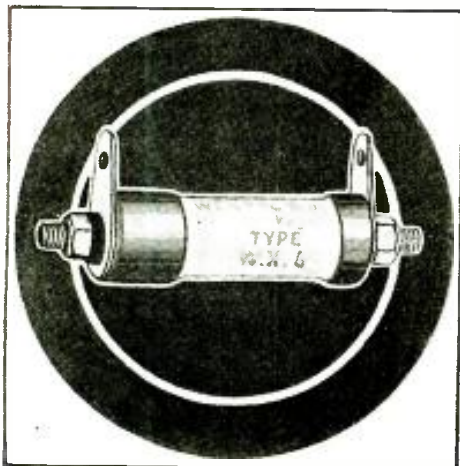

## A GERMAN CAR SET

**I**n Fig. C, is shown a German version of how a car set should be made. This is the new Telefunken receiver. As shown, it is somewhat different from the American types, with its sloping panel extending in front of the instrument panel of the car.

The set contains four tubes and has a "B" unit in the metal cabinet so that the entire power supply for the set is obtained from the car storage battery.

## HIGH-FREQUENCY METAL RECTIFIER

**S**everal times in this department, we have pointed out the use of metal-oxide rectifiers for use as second-detectors in superheterodyne sets and similar uses. However, up to now, these detectors have been limited in their application because they could not operate on frequencies as high as the broadcast band.

Now, however, the frequency range has been increased so that they are efficient as detectors on frequencies up to 1500 kc. This should enlarge their usefulness as many of the sets used in Europe utilize T.R.F. circuits; the superheterodyne being less popular over there than in the U. S.

## A MULTI-CIRCUIT SWITCH

**A** RATHER interesting switch appeared recently in *Bastelbriefe der Drahtlosen*, a magazine published in Germany. Designed particularly for all-wave sets, this switch has numerous contacts and switching sections, but retains a low inter-contact capacity.

The switching is accomplished by a series of cams on the switch shaft. This permits a very flexible control, as cams of different shape can be used to close individual contacts at any desired point on the circumference of the dial pointer. In other words, instead of using cams with a single extrusion, as shown in Fig. 3, cams with two, three, four or even more extrusions can be used. Also different cams can be used on individual sections so that the contacts can be closed at any given point on the dial and remain closed for any desired arc of the dial.

(Continued on page 48)

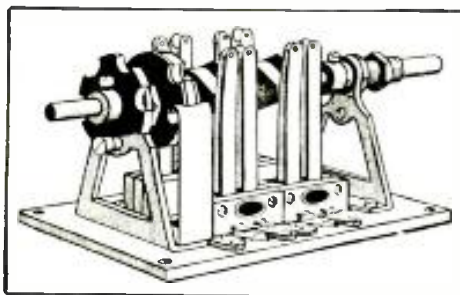

Fig. 3, above  
A cam-operated multi-section switch.

Fig. D, left  
The metal-oxide detector for high frequencies.

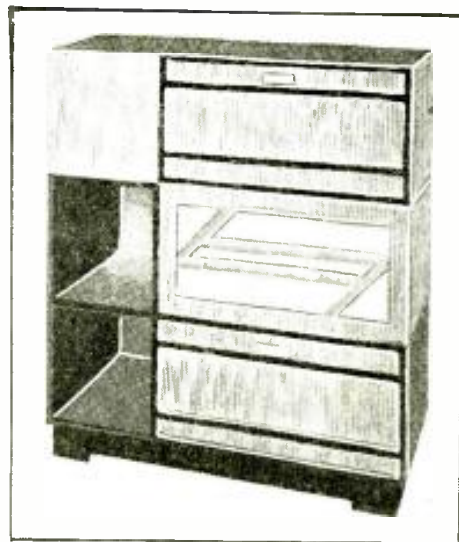

Fig. E  
The modernistic add-on cabinet assembled.

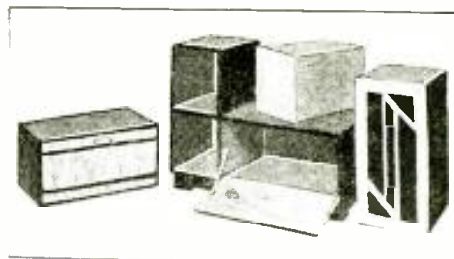

Fig. F  
The parts that make up the cabinet above.

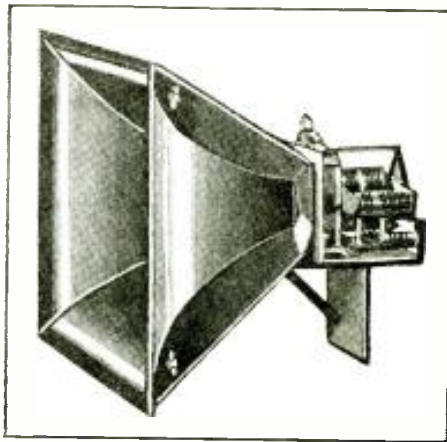

Fig. G  
A special set-up of the 2 cone reproducer.

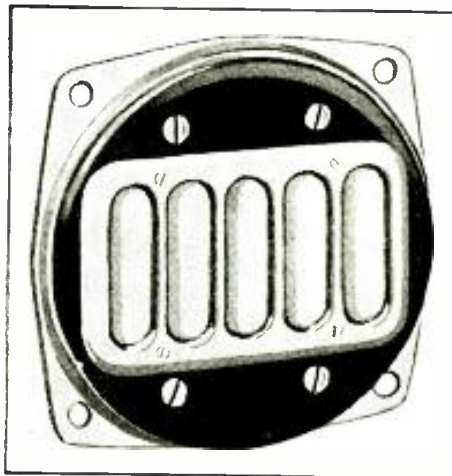
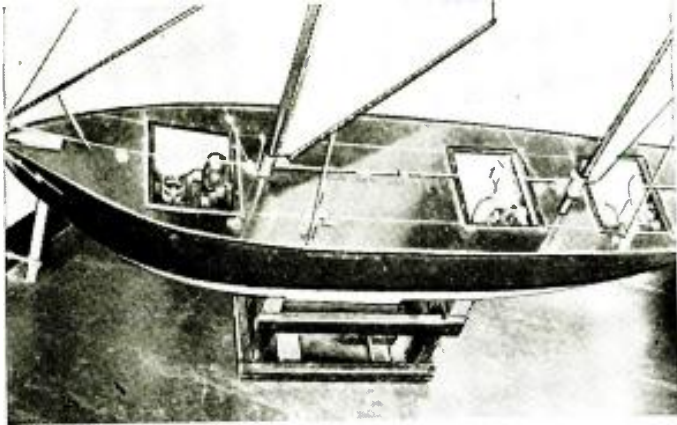

Fig. H  
A transverse-current carbon microphone.

# A RADIO-CONTROLLED BOAT



The completed model, with hatches open to show apparatus.

Interest in that fascinating application of radio, termed radio-dynamics, is being received. It pertains to the control of mechanical devices, from a remote point, by means of radio apparatus. A simple and very easily constructed radio controlled model boat is herewith described. The receiver and transmitter are of conventional design; the special equipment can be easily built.

R. H. PACKARD

There are, without question, many experimenters and constructors who delve into every phase of radio research or construction. The subject of this particular experiment, which incidentally proved very practical and satisfactory, is called "radio-dynamics," and pertains to the control of mechanisms by means of radio. A model sail boat, or yacht (a "ketch," to be exact), was built so that it would satisfactorily incorporate certain other mechanisms that were essential to operate and control it from a remote point. A radio receiver of standard material was constructed and installed; three tubes being employed, comprising detector and two audio stages. As a matter of fact, the receiver is a standard regenerative affair—no special tricks included, since none are necessary—which may be found in use almost any where. A special relay of extreme sensitivity was constructed, operated by the output of the receiver and which in turn controls the piloting or maneuvering of the boat.

The following is a complete description of the various components necessary, their construction, and final operation when installed.

## The Control Equipment

There are at present four separate controls in the boat: (1) rudder to port; (2) rudder to starboard; (3) sheets

hauled in, and; (4) sheets played out. These are performed by pressing the key or push-button at the transmitter 1, 2, 3, or 4 times, respectively, with one dot to stop any of these operations. A selector switch within the boat acts on the impulses from the receiver and makes the proper electrical connections to carry out the desired operations.

The transmitter is a conventional, modified tuned-grid, tuned-plate oscillator operating on 80 meters, unmodulated, and keyed in the negative plate return lead by means of a push-button on an extension cord for convenience; it feeds a half-wave antenna. It uses a type 71A tube with two 45 V. "B" batteries for plate supply and a small home-made 6 V. storage battery for the

filament current supply. The complete unit including batteries can be easily built into a 5 x 8 x 11 in. carrying case, weighing only 16 lbs., although at the present time the set is not extremely compact.

The interrupted radio waves radiated by the antenna of the transmitter are picked up by the antenna on the yacht, a single wire running between the masts and down to the bow, with the lead-in carried to the detector stage of a 3 tube short-wave receiver. Referring to Fig. 1, it is seen that the first stage is a regenerative detector, regeneration being controlled by a variable tickler coil so that the circuit is in an oscillating condition. The incoming radio-frequency signal beats with the local oscillation, giving an audio frequency signal which is amplified in two transformer-coupled stages, the last of which acts also as a rectifier since its grid is biased to plate-current cut-off by a "C" battery. When a signal comes through the rectified current trips a sensitive relay in the plate circuit of this tube closing a contact in the exterior circuit, and when the signal ceases, this contact opens.

The relay is made by winding 24,000 T. of No. 36 wire on a transformer core to make a horseshoe magnet. It has a resistance of 500 ohms with the 2 coils

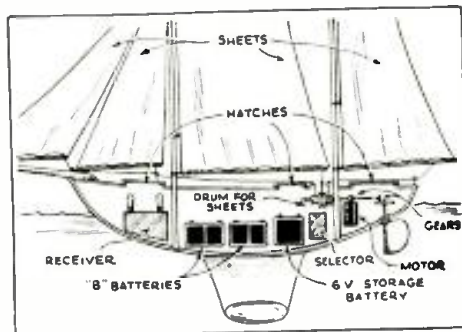

Fig. 2  
Location of equipment in model boat.

(Continued on page 40)

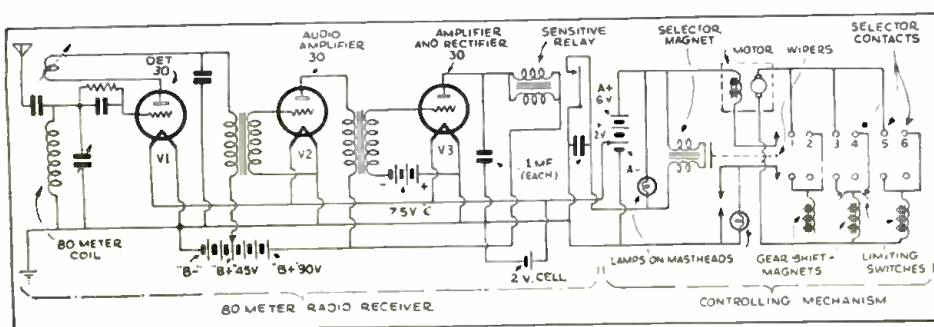

Fig. 1  
Schematic wiring diagram of receiver and control mechanism.

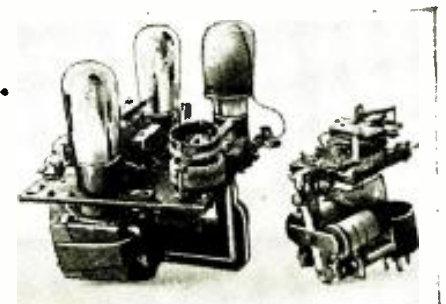

Fig. 3  
The 3 tube receiver and relay.



# A SET SENSITIVITY TESTER

An oscillator when properly understood and used is one of the most versatile instruments in the equipment of Service Men. One built along the lines described in this article will permit a higher standard of efficiency, besides adding that professional engineering touch, in repair work. Some of the possible uses of this tester are:

- (1) Checking efficiency of repaired receivers.
- (2) Comparison of sets.
- (3) Aligning tuned and I.F. stages.
- (4) Tube testing.

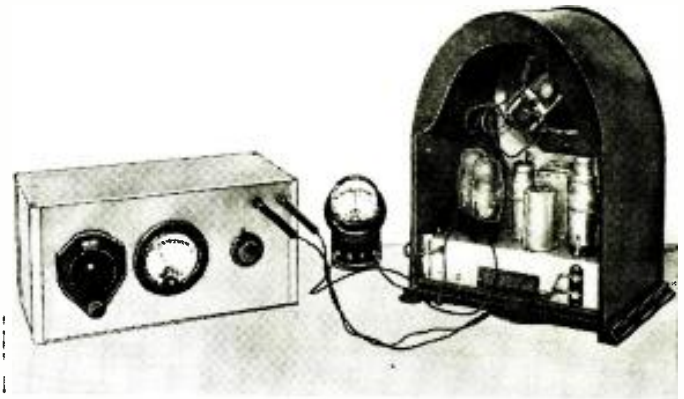

Fig. A. Checking a receiver's efficiency!

J. T. BERNSLEY

**O**SCILLATORS have been extensively used by Service Men, but not all of them fully realize the number of uses to which these instruments can be put. In a laboratory, the oscillator is one of the most versatile instruments, being employed for most major engineering operations in design and measurement work. In servicing work, most men simply use it for aligning receiver stages. By a few simple changes, (or if desired this complete unit can be constructed for less than five dollars, excluding meters) the oscillator that is on hand can be made so that it will perform any of the operations to be described.

### Construction

Fundamentally this "tester" is similar to any oscillator. It is a self-modulated oscillator employing a type 30 tube, batteries and everything self-contained, but includes an 0-1 ma. milliammeter in the plate circuit to indicate the existing output when the oscillator switch is turned "on." The reason a meter of this range is employed is not only because a tremendous output is not really essential, but because "high" output is not desired for checking the sensitivity of a set. Due to the low plate voltage applied to the tube

(45 V. maximum, although  $22\frac{1}{2}$  V. is sufficient in most cases) the plate current will never exceed 1 ma. and may be regulated by the filament rheostat which is included in the design of the unit. In actual use, when testing an average receiver, a plate current of 0.4-ma. was sufficient to produce a sizeable output reading on the output meter.

The frequency range is from approximately 100 kc. to 1,500 kc., the higher frequencies being harmonics of fundamental frequencies in the tuning range of the coil and condenser. Although the coil used in the construction of this oscillator was from an I.F. transformer whose peak was 350 kc. (and from which the padding condensers were removed), the required coil may be easily constructed and all details are shown in Fig. 2.

The value of the coupling condenser in the output (plate) circuit which connects to the receiver should be low. Approximately 50 mmf. will be sufficient

(Continued on page 52)

Fig. 4, below.  
Calibration chart for oscillator.

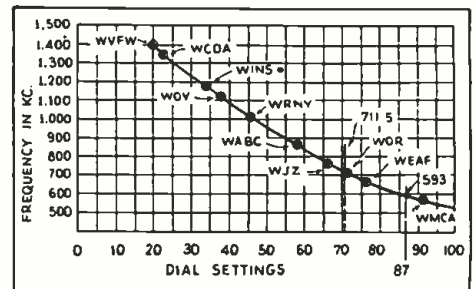
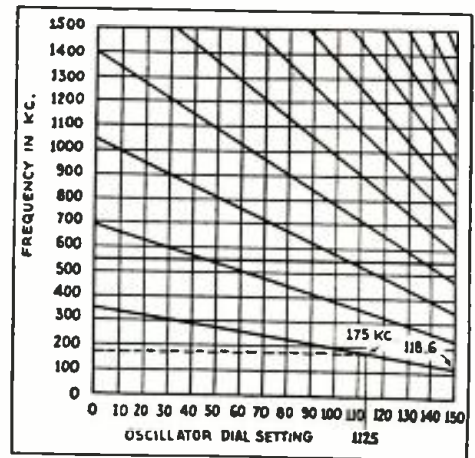

Fig. 3, above.  
Broadcast stations and calibration.

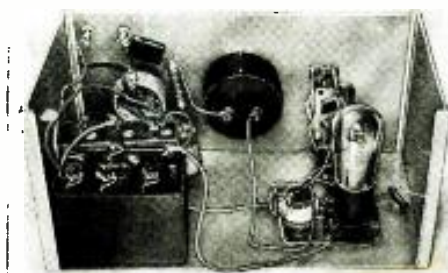

Fig. B  
Internal view. Few parts are necessary.

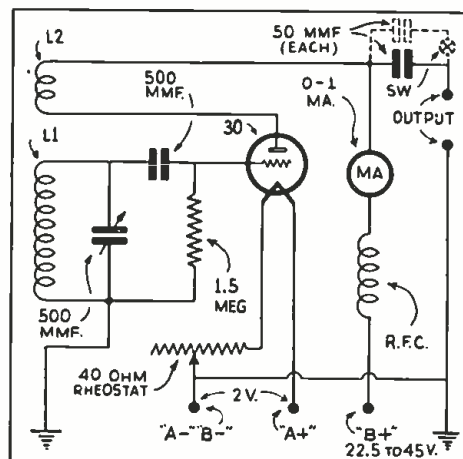

Fig. 1  
Schematic diagram of oscillator.

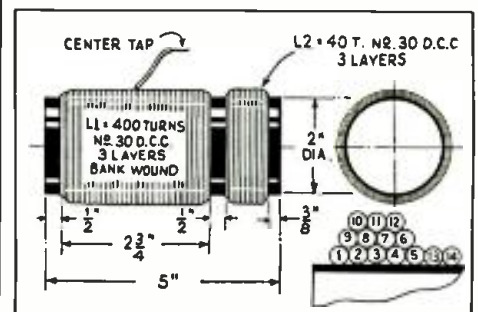

Fig. 2  
Constructional details of coil.

# IMPORTANT FACTS ABOUT THE NEW ALL-WAVE ANTENNA SYSTEMS

R. D. WASHBURNE

PART I



Fig. A  
A "double doublet" antenna kit.

Throw away your "1904" antenna! Install a "1934" type! Result: satisfactory, noise-free all-wave reception of foreign radio programs. The author describes the "double doublet" and other up-to-date antenna systems that result in marvelous reception on 16 to 550 meters.

**R**ADIO sets have received the concentrated consideration of the entire radio engineering field until, today, we have highly-perfected "all-wave" receivers designed to enable us to grasp invisible hands that extend from foreign climes across the seven seas.

Vacuum tubes, too, have received specialized attention so that, now, we even have "all-wave" tubes—electronic units of superlative design which, incorporating such ultra-modern characteristics as we find in the new type 1C6 tube, meet the exacting demands of this latest and most enchanting service.

But what has been done about improving that bottle-neck, the radio antenna—the radio receiving set's source of broadcast energy? Perhaps some of the owners of all-wave sets who read the following data will be greatly surprised to learn that a good 1 tube set may "run rings around" their fine, new multi-tube receiver, "with all modern improvements," simply because the former instrument is used in conjunction with an efficient antenna system, in contrast to the latter, 1934 set which is using an out-moded, 1904 antenna system! (In this connection, see HUGO GERNSBACH'S editorials, "All-wave Sets," and "Radio Noises," in the January and June, 1934 issues of RADIO-CRAFT, respectively.)

Before we go a single step further, let us state without any equivocation—it is sad *but true*, that only a very elaborate or intricate antenna arrangement, involving substantial costs, will meet the specification for an *ideal* all-wave antenna system. However, there is good news in the fact that a most amazing improvement in noise-free and reliable reception of over-seas radio station programs may be effected by utilizing the very latest developments in all-wave antenna installation technique.

## Types of All-Wave Antennas

Leaving technical comments aside for the moment, let us consult a listing of the 7 most suitable, new all-wave antenna designs, in their respective order, as follows:

- (1) Double doublet (Figs. 1 and A).
- (2) Inverted-L with unshielded lead-in (Fig 2).
- (3) Doublet with transposed lead-in and tuned or untuned impedance-matching transformer (Figs. 3 and B).
- (4) Doublet with transposition-cable lead-in and no impedance-matching transformer (Figs. 4 and C).
- (5) Inverted-L or T-type, with transposition-cable lead-in and no impedance-matching transformer (Fig. 5).
- (6) Doublet with twisted-pair lead-in and broadcast—short-wave change-over switch (Fig. 6).
- (7) Composite Marconi and Hertz antenna (Fig. 7).

An illustration of each type of antenna installation, accompanied by a discussion of its characteristics, is not quite sufficient material to enable the average radio set owner to adequately determine the most suitable type to meet his individual requirements. However, reference to Fig. 9 will start the radio man on the right foot; Figs. 2 to 8 are shown and described in Part II.

Although there are only two fundamental types of antennas—the Hertz, which does not require a ground, and the Marconi, which does—there are numerous variations of these. The problem, then, for efficient "all-wave" reception is to find the most suitable design that will result in maximum signal strength and *minimum interference*—the two go hand-in-hand—on wavelengths from about 16 to 550 meters (approximately 18,750 to 550 kc.), or *even more* (late "short-, medium-, and long-wave" sets receive wavelengths as high as 2,000 meters (about 150 kc.); the longer range includes many high-power foreign stations).

## Antennas for "Ground" and "Sky" Wave Signals

Transmitted signals of any wavelength are known to divide into two components—the "ground" wave and the "sky" wave. The ground wave remains close to the earth's surface, providing reliable service only over short distances from the broadcast station. A grounded antenna, the Marconi inverted-L type shown in Fig. 9B, is especially suitable for ground-wave signal reception. Increased signal strength is obtained by increasing the length of the long flat-top. This type of antenna lacks sharp resonance peaks and therefore is only broadly resonant. The major direction from which signals are received by the long flat-top portion of the receiving antenna is indicated in the figure by a horizontal arrow (the receiving equipment is indicated by detector arrow (the receiving equipment is indicated by detector Det., and the transmitting, by spark balls S and generator Gen.).

The sky wave, on the contrary, travels up to the semi-conductive envelope that we now know enshrouds the entire earth at a considerable distance and is reflected back to the earth's surface at an appreciable distance from the station. With short-wave signals, the sky-wave usually does not return within the radius covered by the ground wave, resulting in a so-called dead-spot region within which reception is impossible or extremely unsatisfactory. The length of the region wherein such conditions are effective is known as the "skip distance," varying greatly from day to night and from summer to winter approximately as shown in Table I.

An ungrounded antenna, the Hertz doublet-type shown in Fig. 9A, is especially suitable for sky-wave signal reception. Although no more effective than a correctly-installed inverted-L type on wavelengths to which it is *not* tuned, the doublet antenna is extremely efficient in the region of the

Table I

EFFECT OF TIME OF DAY AND SEASON ON SHORT-WAVE RECEPTION

Wave-length (Meters)	Ground-length Wave Range (Miles)	Sky-Wave Reliable Range (Miles)			
		Summer		Winter	
		Noon	Midnight	Noon	Midnight
100	90	90	600	100	2,500
49	75	100-200	250-5,000	200-600	400*
31	60	200-700	1,000*	500-2,000	1,500*
25	50	300-1,000	1,500*	600-3,000	2,000*
19	35	400-2,000	2,500*	900-4,000	X
16	16	700-4,000	X	1,500*	X

(\*Unlimited distance. X ordinarily cannot be heard.)



pronounced peaks which occur at its resonant and harmonic frequencies. Also, the doublet is highly directional, and receives best from directions at right angles to the direction in which the wire is stretched, as indicated by the vertical arrows in Fig. 9A. The directional characteristic of a doublet whose two wires or "dipoles" X and Y run in a straight line north and south, let us say, will be directional east and west. Now, by tilting the doublet so that the south end, for instance, is low and the north end is high, an added directional preference to southern signals will be observed.

When sections X and Y are not run in exactly the same direction, or their lengths are unequal, the doublet effect is reduced, and the antenna system begins to function as an aerial and counterpoise. In the latter instance, with the counterpoise immediately beneath and parallel to the antenna, the spacing between counterpoise and aerial should be no less than  $\frac{1}{4}$  the height of the antenna above ground. The main points to be remembered in erecting such a modified or folded doublet, are: (1) the space partially enclosed by the two sides of the antenna system is noise free, and; (2) the transposed lead-in should be connected as high up as possible.

#### Man-Made Interference Limits All-Wave Reception

Checking back at this stage of our analysis we find that there are 3 outstanding characteristics of the doublet antenna, to wit: (1) resonance at the fundamental and harmonic frequencies; (2) high directivity, and; (3) pick-up and lead-in sections of the antenna system maintain their functions independently of each other. These characteristics especially recommend the doublet for quiet reception of distant stations. Although reception on the short wavelengths is less affected by "atmospherics" (natural static) and good results may be had in midsummer even during a thunder storm, *the reverse is true where the interference is man-made.*

Electrical machinery such as trolleys, dial telephones, motors, electric fans, automobiles, airplanes, electrical appliances, flashing signs and oil burners create far more interference to reception of the shorter-wave signals than to reception of programs in the "standard" broadcast band of 200 to 550 me-

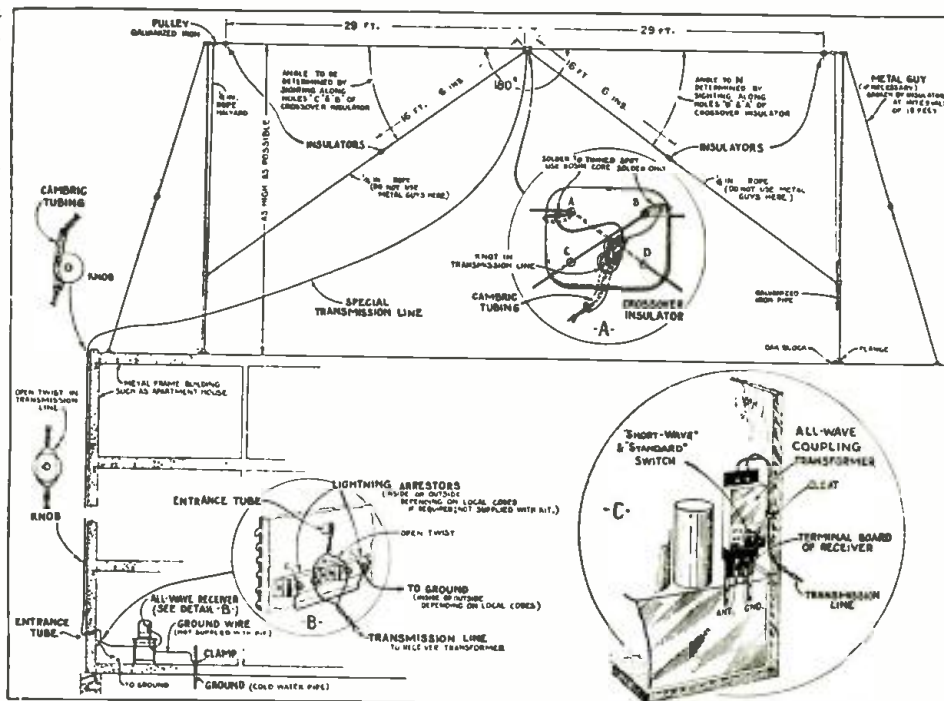

Fig. 1  
The new "double doublet" all-wave antenna installation.

ters. In tests it has been noticed that stray conductors such as antenna wires, and power lines, *re-radiate* noise interference that has been radiated at a remote point and picked up by these conductors; this demonstrates the need to keep the flat-top or dipole section of the Marconi or Hertz antenna system, respectively, as far as possible from such wires.

If necessary, where the local interference covers a considerable area, it may be advisable to locate the antenna 400 or 500 ft. away—perhaps on another building—, running only a shielded lead-in or a transposition line through the area of interference.

Locating the antenna at a point removed from sources of interference is *very important*, inasmuch as the strength of broadcast signals received from a considerable distance varies almost directly as the distance—whereas, local interference signal strength varies as the square of the distance. Thus, by placing the antenna 20 ft., instead of 10 ft., for instance, from a source of local interference the ratio of broadcast signal strength to interference signal strength is improved approximately 4 times.

To still further improve the signal-to-noise ratio, place the antenna as high as possible. By so doing, two desirable results are secured: (1) an increase in height means getting the antenna further away from sources of noise, and; (2) the greater the height, the greater will be the signal pick-up.

Finally, to receive the most distant stations, secure an even higher signal-to-noise ratio by being careful to install the antenna in a location isolated from nearby wires, trees, building walls, roofs, etc. Such objects reduce the efficiency of the antenna system by absorbing signal energy before it can reach the antenna.

#### The Lead-in of the Doublet Antenna

The doublet antenna provides maximum signal response on signals of a wavelength which has a certain relationship to the length of the flat-top portion of the antenna system, and this characteristic ordinarily is unaffected by the length of the transposed twin-conductor R.F. transmission line that constitutes the lead-in. For best results on a given wavelength the lengths of dipole sections X and Y, in Fig. 9A, should each be  $\frac{1}{4}$  of the desired wavelength. This exact length for the dipoles of the doublet is conveniently obtained by dividing 492,000 by the desired frequency in kc., and multiplying the result by .95, for accurate figures on wavelengths of 20 meters and above. The result is the length of the flat top, in feet; this length is now halved by breaking the length with a strain insulator placed at the exact center. Of four dipole ends thus formed, two terminate at this insulator and connect to an R.F. transmission line or twin-conductor lead-in whose wires are "transposed."

The two wires that compose this "transposition lead-in" are interchanged every few inches in their respective positions in order to eliminate the pick-up of local interference. This reduced pick-up of noise is due to the fact that any current set up in one wire is neutralized at the coupling coil or impedance-matching transformer by the current simultaneously set up in the other, parallel wire. Of course, if man-made interference is introduced in the set via the power line (to which the set is connected) before even the lead-in is connected to the set, the antenna system should not be blamed in this instance if its correct installation does not result in more noiseless operation; in cases such as this one an all-wave power

(Continued on page 46)

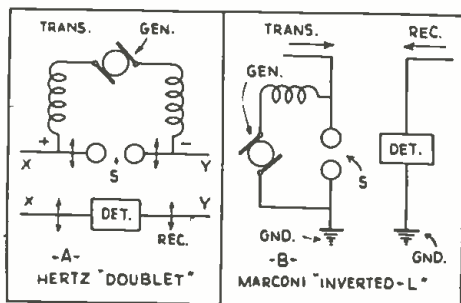

Fig. 9  
Fundamental antenna systems.



Fig. A

G.E. B-52, duo-purpose radio for automobile or home use. Operates on auto battery or 110 V. A.C.

# NEW AUTO

Auto-radio receivers have improved considerably in design and appearance in the past few months. Practically all models are now constructed in single unit fashion, containing dynamic speaker and "B" supply unit. Tuning controls are improved in appearance and mechanical construction. The circuit improvements and tubes used are such as to produce an efficiency equivalent to that of an excellent home receiver.



Fig. B

Simply attach plug for 110 V. A.C. use



Fig. E

Motorola, Dual 6—Super heterodyne, employs 2-78's, 1-77, 1-75, 1-42, and an 84 rectifier or Elkonode No. 53 "B" power rectifier unit. Airplane type tuning control and dynamic speaker. A tone control is provided to compensate for car acoustics.



Fig. C

Majestic 66, 6 tube superhet.

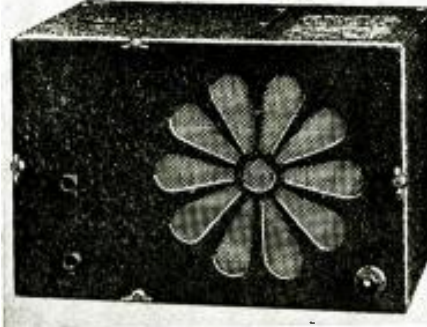

Fig. F

Audiola 346, 6 tube superhet. Manufacturer specifies that no suppressors are necessary.

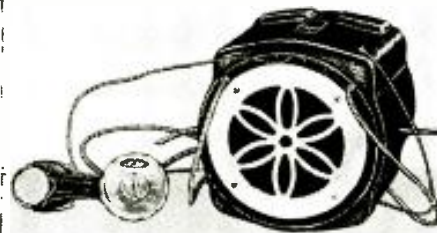

Fig. D

Arvin 25, 6 tubes and 6 in. speaker, 8 point tone control. Easily installed.

THE auto-radio receiver of a few years ago was a crude affair, in comparison with present models. Whereas the old model consisted of numerous boxes to hold the receiver chassis, speaker and "B" batteries, and the tubes were such that very little amplification of the meager signal (generally obtained from most auto antennas) fed to them was derived; the new sets are practically just the opposite in that every imperfection existing in earlier models has been eliminated. The latest in auto-radio receivers is a single unit with just one or two bolts, at the most, necessary to anchor it to the car. Today, "B" batteries have been entirely done away with, a "B" supply unit that obtains its power from the car battery being employed to furnish the necessary plate voltages. This unit may be either of the motor-generator type, or a vibrator which chops the 6 V. D.C. (from the storage battery) into pulsating D.C., stepped-up by a transformer to approximately 225 V., A.C. and then rectified and filtered by a special rectifying tube and filter arrangement. Some receivers employ a mechanical rectifier, operated "in step" with the vibrator "chopper,"

Fig. H

RCA Victor, M105, 4-tube superheterodyne. Employs a mechanical inverter and rectifier for "B" supply, thus eliminating a tube.



Fig. G, left

Studebaker-Philco. Special tuning control arrangement for instrument board or compartment.





# SETS AND FEATURES

The installation procedure for auto sets has also been refined considerably. A radio receiver in a car now is a thing of beauty, in addition to being a necessary convenience. As suggested in the photographed illustrations below, the tuning controls may be so located in any one of various places in a car, that it will contribute to the tuning ease and interior appearance. Many new cars include radio as standard equipment.

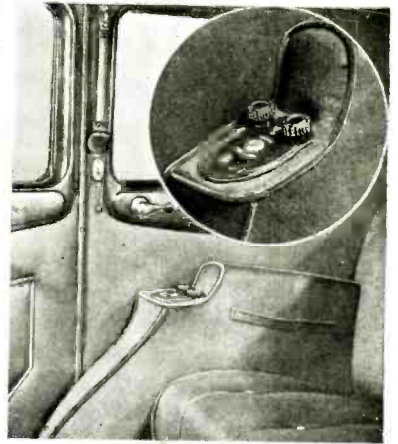

Fig. J  
Packard radio tuning control in arm rest.

to eliminate the necessity for an extra tube.

Essentially, what has been, to a great extent, responsible for the tremendous improvement in efficiency of present-day car sets is the development of new and improved tubes. Such tubes as the 6A7, 6B7, 78, and the 41 permit greater amplification, larger power outputs at initially lower plate voltages, besides a circuit arrangement that enables the tube to perform double functions, such as composite first-detector and oscillator, or second-detector and A.V.C. or I.F. stage. This, when summed up, means simply that a tremendous saving in tubes is accomplished without impairing the efficiency of the receiver. In addition, the versatility of these tubes permits the attaining of 3 tube efficiency from one, by means of multiple functions (outlined) and reflexing. As a matter of fact, most of the 5 and 6 tube receivers that are manufactured are the equivalent of 7 and 8 tube sets of a few years ago.

Insofar as reproduction is concerned, the new auto sets reproduce with a quality comparable to most home receivers. Some of these new sets employ class A<sub>1</sub> amplification in the final audio stage, so that a relatively large power output is delivered to the speaker, resulting in ample volume without "forcing" the volume control until that strained quality or tone is obtained. Of course, all of the present manufactured models include the dynamic type of loudspeaker.

## G. E. Model B-52

In Figs. A and B are shown an auto radio set that is more than an ordinary auto radio; it is made by General Electric  
(Continued on page 49)

Fig. I

A special airplane-type tuning control is installed, with receiver, at the factory of the Hudson Motor Car Company. It harmonizes with all other instruments.

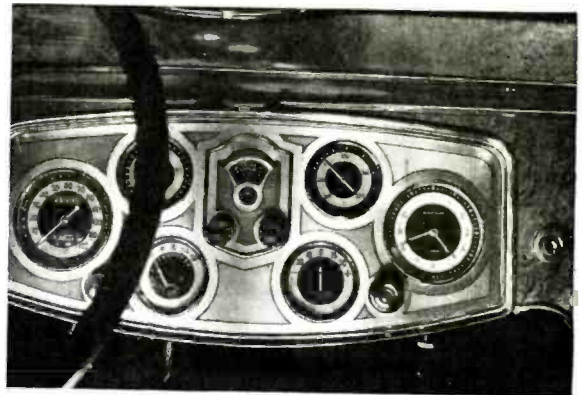

Fig. K  
Packard, tuning control on instrument panel.

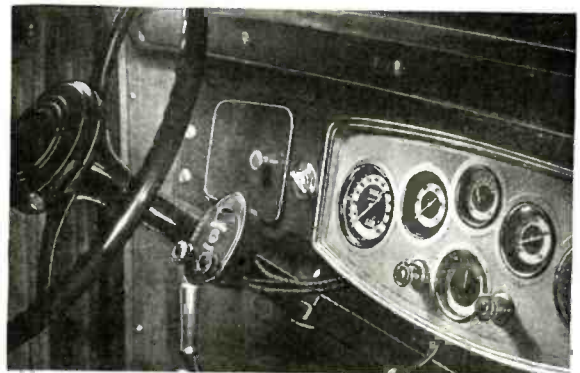
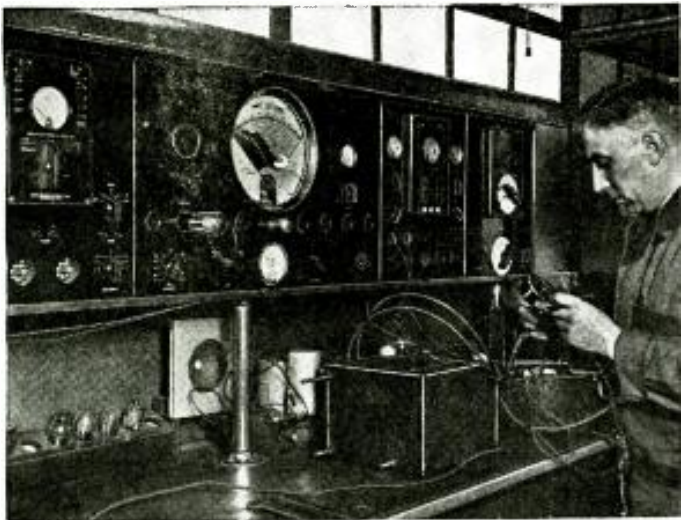

Fig. L, above  
Standard type installation (Packard), tuning control mounted on steering column. Set mounted behind instrument board.

Fig. M, below  
Tuning control matched with instruments in Studebaker.



# AUTO RADIO INSTALLATION



**Fig. A**

A modern and well-equipped auto-radio service shop.

(Photos A and B, courtesy Halbran)



**Fig. B, above**

Screened cage for testing receivers in cars; the screening minimizes external R.F. interference.

**Fig. C, below**

A car radio antenna rod.

Photo courtesy, Tobe Deutschmann Corp.

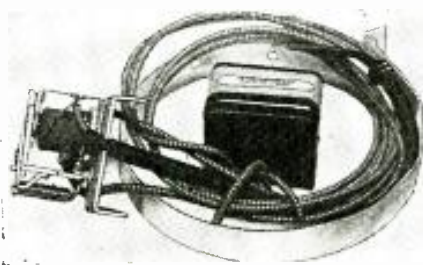

**Fig. D, above**  
Device for automatically increasing charging rate. Courtesy, A. H. Lynch, Inc.

**Fig. E, below**  
Auto antenna matching-transformer unit.

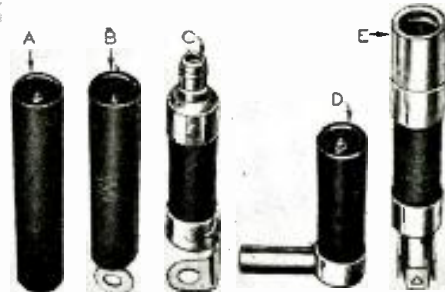

**Fig. F, above**  
Standard types of ignition-noise suppressors; see text for applications.  
Photo courtesy, International Res. Corp.

**Fig. G, below**  
Inductive type of suppressors.  
Courtesy, A. H. Lynch, Inc.

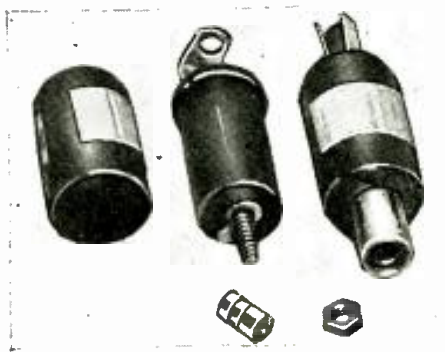

**I**N STEP with the improvements made in auto-radio receivers in the past year are improved methods for installing these sets and the elimination of motor noise. The many thousands of sets that were installed in cars since this form of car pleasure became popular have served to increase by a considerable amount the knowledge of car radio set installers. By this time most installation men now have a fixed procedure or routine for eliminating motor noise from certain makes of cars. Unfortunately, despite this constant experience the amount of labor and detail involved have not been materially reduced, that is, not up until a few months ago. However, with the introduction of new devices, designed to materially increase the efficiency from auto-radio sets and reduce motor noise pick-up, it seems probable that installation men will no longer dread the installation work in certain types of cars. Their work has already been considerably lightened by the foresight of present-day receiver manufacturers in designing their new sets. Most car sets employ only two or three bolts at the most to fasten the complete set within the car. Compare this with the numerous holes and bolts necessary to mount the various units that comprised an automobile receiver a few years ago, and we can readily realize the time and labor saved by present improvements.

As regards the routine for ignition noise reduction or elimination, certain salient operations are necessary with every car, and from then on, depending on the car, it becomes a matter of "cut and try" or "hit and miss" endeavors. Some of the very difficult ones sometimes require practically complete shielding of all low- and high-tension wires, in addition to the suppressors and condensers that must be installed. It has been noticed, by those actively engaged in auto-radio installation work, that the following will aid materially in effectively reducing motor ignition interference:

- (1) Bonding and grounding all cables and pipes that





# NEW AUTO-SET DIAGRAMS.

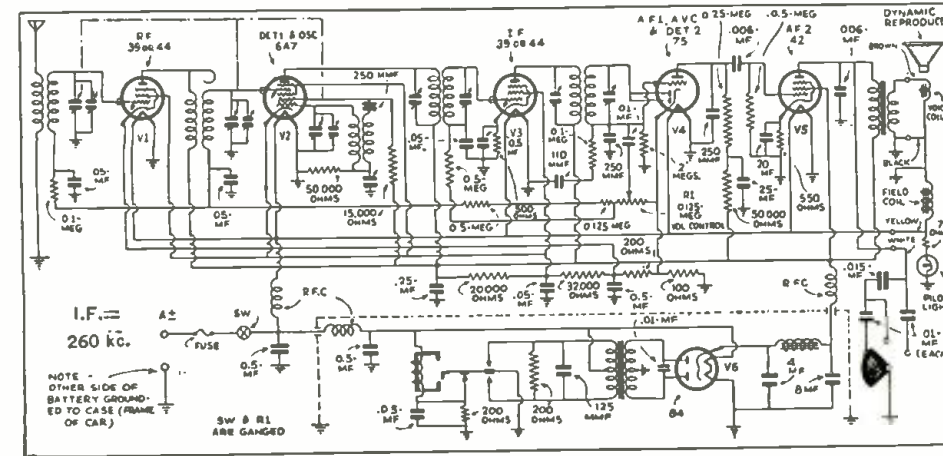
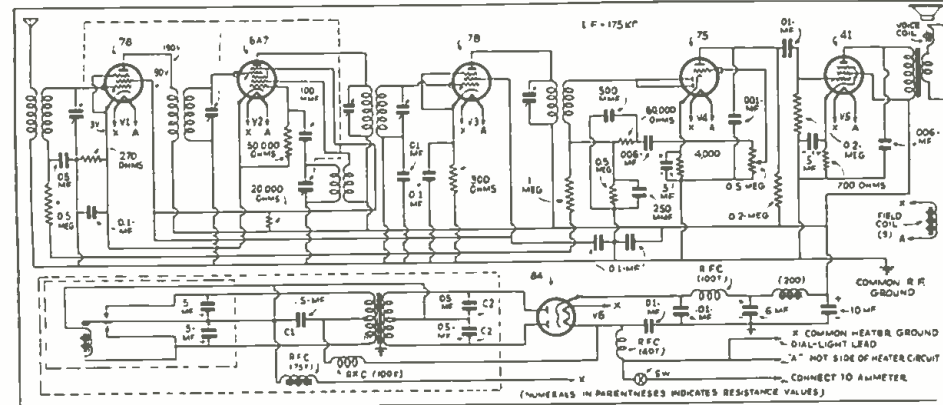
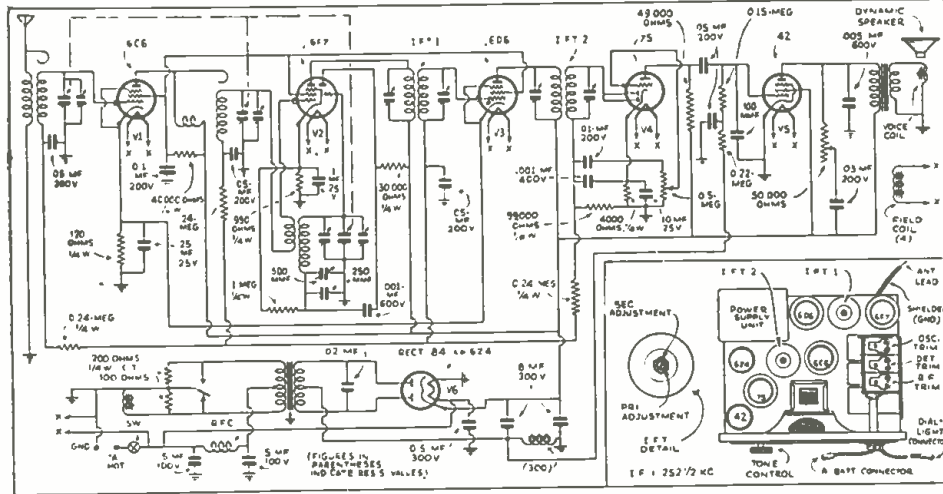
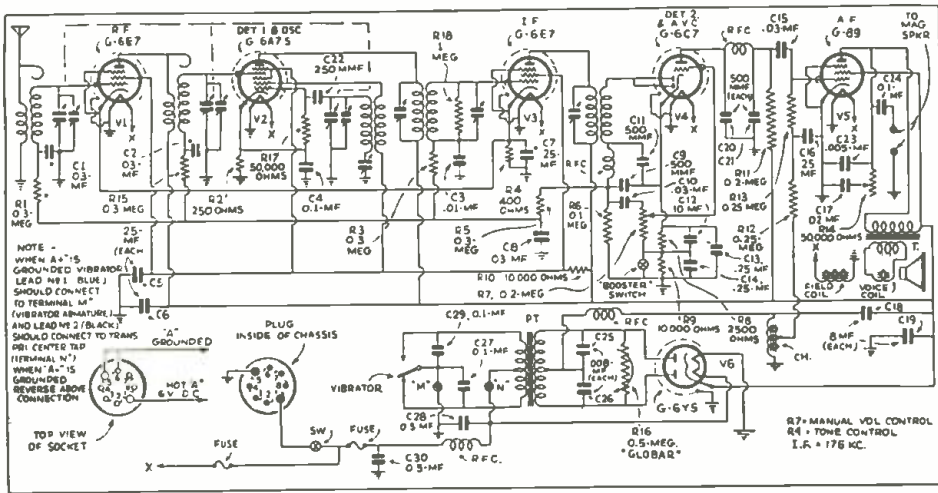



## MOTOROLA DUAL 6

**S**ALIENT information regarding this receiver may be obtained by reference to diagram on left. When servicing, the audio end of the chassis may be checked by removing the control-grid cap of the 75 and, if normal, a loud hum will occur. To check the oscillator circuit, turn the variable condensers to "minimum" position and touch the oscillator stator plates. A click should be heard when plates are touched and again when fingers are removed—to indicate that oscillator is functioning.

For alignment of I.F. transformers signal generator output should be connected to the grid of the 77 first-detector and oscillator tube. Remove the grid cap and connect a .5-meg. resistor from grid to ground.

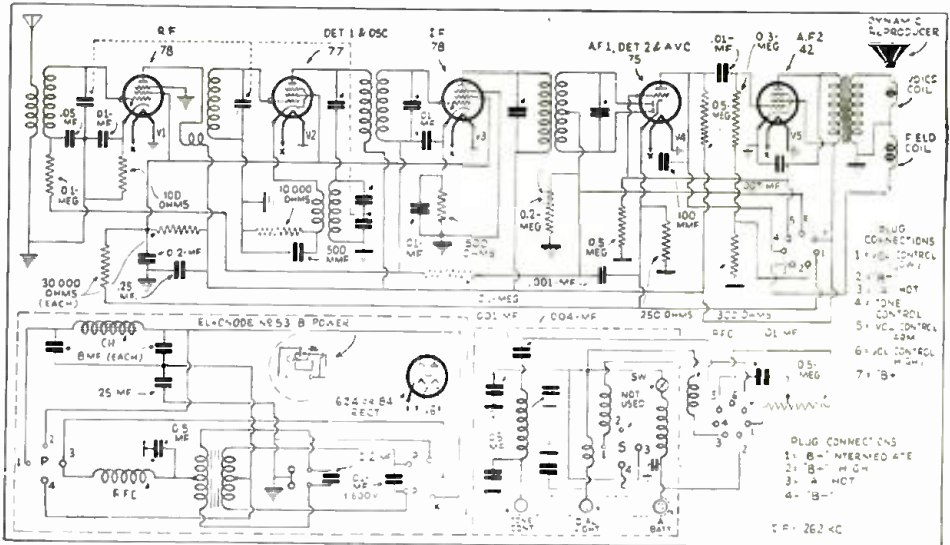

## ATWATER KENT MODELS 816, 926, 936

**S**CHEMATIC wiring diagram of circuit for these three models is shown on right. In lower right hand corner wiring of motor-generator type "B" supply for models 926 and 936 is shown. Model 816 employs a mechanical inverter and rectifier, thus eliminating rectifier tube.

All voltage measurements are indicated on drawing, and were made with sensitivity switch at local position (switch open).

Aligning procedure and servicing tests are similar to those mentioned for other receivers. Output of signal generator should be connected to grid cap of 6A7 tube after terminal is removed. I.F. peak 264 kc.; receiver is best aligned when chassis and generator box (926 and 936) are grounded.

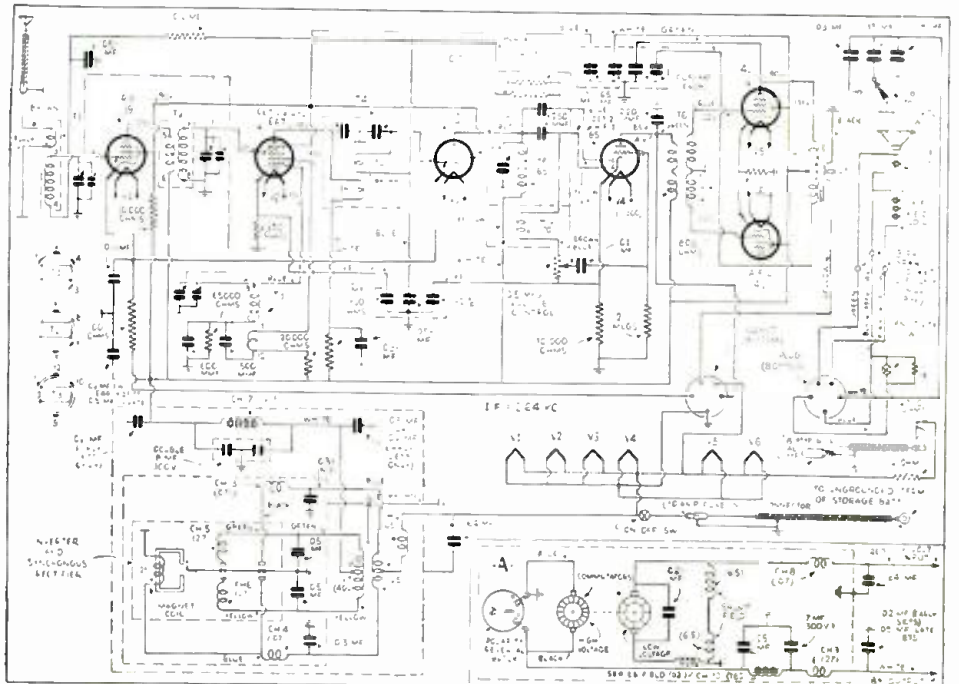

## AUDIOLA 346

**M**ANUFACTURER recommends after installation is completed that antenna trimmer be adjusted on distant station around 1,400 or 1,500 kc. for loudest signal. Antenna trimmer will be located directly under serial number on top of set. This adjustment will provide maximum sensitivity with individual types of car antennas.

For special cases of ignition interference the filter shown in lower left hand corner of diagram will prove very effective. Insert in "hot" lead from set and as close to set as possible.

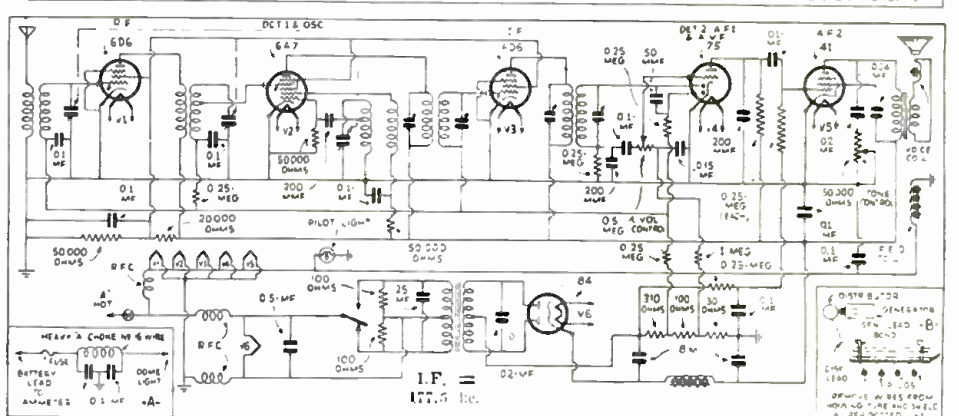

## RCA VICTOR M-105

**O**NLY four tubes are employed in this model, as shown by the diagram. A vibrator type inverter-rectifier replaces the rectifier tube, and if servicing of this unit is required, it should be completely replaced.

All R.F. adjustments can be made with receiver in case.

Socket voltages are as follows:

Tube Type	Cath. to Ground	Cath. to Sc. Grid	Cath. to Plate	Cath. to Ma.
78-R.F.	4.42V.	83V.	222	5.25
6A7-1st.	4.42V.	83V.	222	11.00
6A7-Osc.	4.42V.	—	222	
6B7-Det. 2	3.22V.	84V.	218	5.25
41 Power	130.V.	214V.	200	26.00

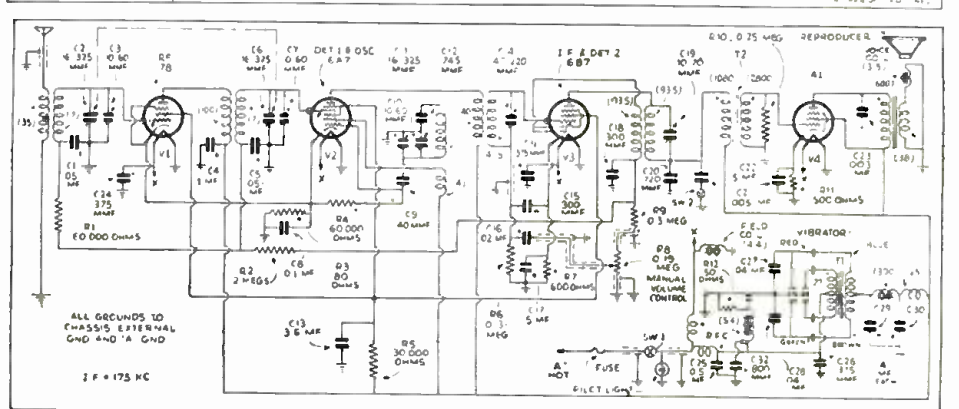

# A 3 TUBE A.C. SHORT-WAVE SET

This receiver, though simple to build, is nevertheless highly efficient and reliable in its operation. It may be operated either from batteries or 110 V. A.C. power supply. Complete details of the receiver and power pack are included.

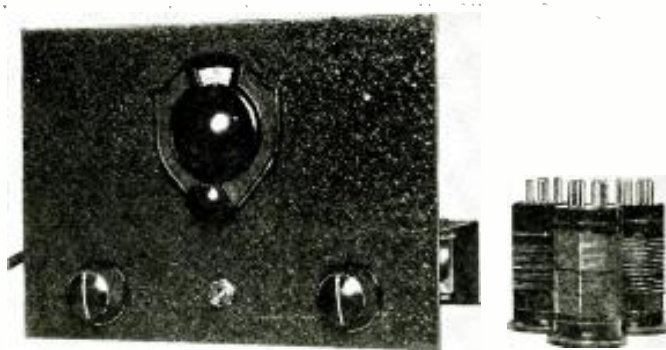

FRANK LESTER\*

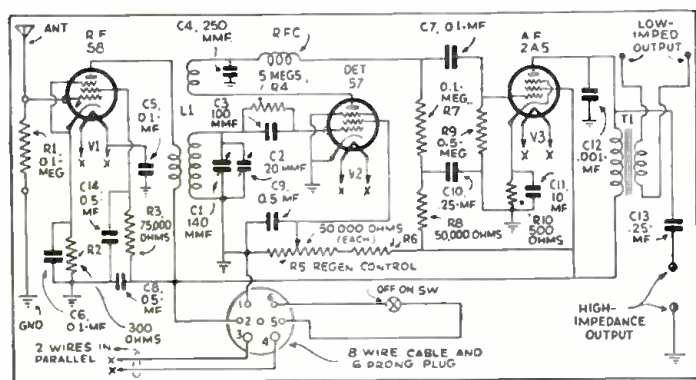

Fig. 1

Schematic. First stage untuned, second tube detector with regeneration, third tube resistance coupled audio stage. Power pack connections shown in continuation.

**M**OST of the simple and low-priced short-wave receivers that have been brought out recently for DX enthusiasts who want to hear foreign stations are of the battery-operated type, and therefore do not particularly appeal to people who have grown accustomed to the convenience, reliability and economy of house current operation. These sets fill a definite need, but radio listeners who have not bothered with batteries for years would much prefer to "get into short waves" with a small A.C. set.

To fulfil this requirement and to get these people exploring the busy short-wave channels, the writer has designed a simple but effective A.C. short-wave receiver that uses the latest tubes in a dependable, hum-free circuit, and that costs very little more than the average battery model complete with all its necessary "A," "B" and "C" batteries. The powerful A.C. tubes, of the pentode type, make possible, under favorable conditions, comfortable loudspeaker results

(Continued on page 42)

\* Engineer, Wholesale Radio Service Co.

# A PRACTICAL LINE FILTER FOR ALL-WAVE RECEIVERS

At last! A really practical and inexpensive line filter that materially decreases noise in the all-wave receiver caused by line pickup of "man-made" static. Complete constructional details are given so that any novice can build it.

A. D. LODGE



**W**E HAVE modern selective receivers and we erect carefully designed antenna systems, yet all these precautions are

in a measure spoiled if we overlook the greatest remaining collector of noise—the house wiring that offers a conductive path from the many sources of

man-made disturbance directly into the heart of our receiver. Through this unguarded portal may enter the roars, crackles, and sputters that mar the otherwise perfect reception of distant stations. True, there have been many line filters, but being in general designed primarily for the broadcast receiver, they are practically inoperative on the higher frequencies.

The writer's assistance was requested in clearing up a particularly troublesome case of noisy reception. Every known noise reducer—doublet antenna; transposed lead-in; ordinary line filters; etc. had been tried but there still remained an annoyingly high noise background. It was then decided to tackle the prob-

(Continued on page 40)

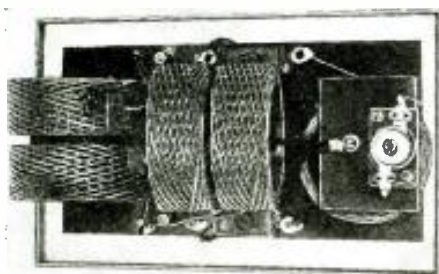

Fig. A

Inside view of line filter panel. Coils L1-L2 are placed at a right angle to L3-L4.

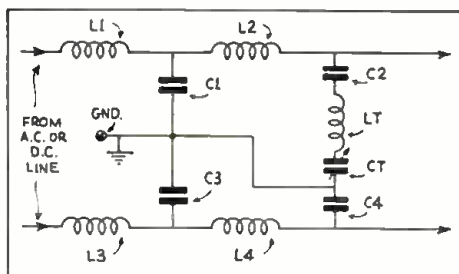

Fig. 1

Diagram. Only 4 H.C. Coils and 5 condensers employed.



# UPLIFTING THE SERVICING PROFESSION

"Thar's gold in them thar" suggestions and hints, for Service Men, which are contained in this issue.

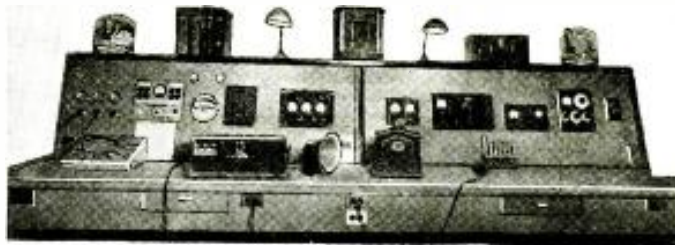

Photo courtesy Nat'l Union Tube Corp.

Second prize winner; Edward Radio Service, Washington, D. C.

## PART II

F. E. COLT

**C**LEANLINESS for a business is as important as personal attire. How many times have you been in a repair shop and seen things piled up in piles, a dirty bench top, dirty floors, a junky looking "dump." Dump is the right word here, as some shops look as though their contents had been dumped in place. There is no excuse for it either, just laziness—that's all.

Radio service work should be a little more refined. Your best customers will be ladies. It is the ladies of the home who will have the service work done so we must tone up the shop, make it attractive so that the ladies can come in and feel that they are not entering a "grease joint." Let's form our first rule right now. *This shop must be kept clean and orderly.*

### The Shop Arrangement

In part of this series, were diagrams of the suggested arrangements, and a study of them will give you more of an understanding than can be written.

As was stated before, place your bench near one of the display windows which will allow you to have as much daylight as possible. If it could be arranged so that a skylight could be installed over the center of your work shop, letting in natural light, your light bill could be kept down. In placing the bench in the show window, I believe that by allowing a three foot depth show window is all that is necessary for a small display. It will let you near enough to the glass to receive all the light from that window. See drawing of Plan of Shop Arrangement.

The nicest size of benches to build is 3 ft. tops x 6 ft. in length for test bench and work bench while for counters and machine table 2 ft. x 6 ft.

In the drawing showing a shop arrangement, you will note the radio test bench has a switchboard of 6 panels. These panels are each removable and, as you will note, contain 3 basic test panels which I believe, have more practical use than anything else you could build. The first panel is nothing more than a switching panel with bench light, switches, A. C. line voltmeter and a series-multiple test lamp for 110 A.C. operation with a plug-in receptacle and binding posts. The second panel from the left is just a good old reliable elec-

tric clock so that you may estimate the time it takes to do a certain job. Panel No. 3 from the left is a power panel having "B" voltages, "A" voltages and "C" voltages, speaker jacks and high voltage jack with the "B" power supply from under the bench as well as the "A" and "C" batteries. The panel on the bottom row from left to right (No. 4) is an eleven section bank condenser bridge for substitution purposes and the No. 5 panel is a condenser tester. This is certainly a practical and handy method of testing for open condensers as you do not have to disconnect the condensers to check them.

The 6th panel is a resistor bank made up from a .1-megohm variable resistor test unit and has in connection ten

*(Continued on page 53)*

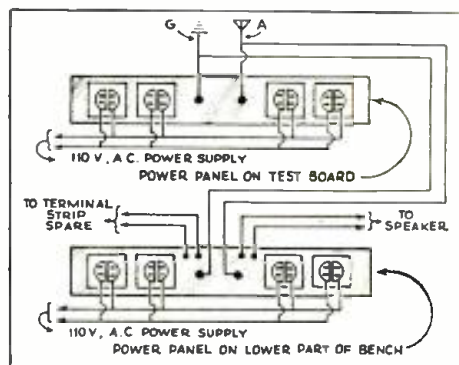
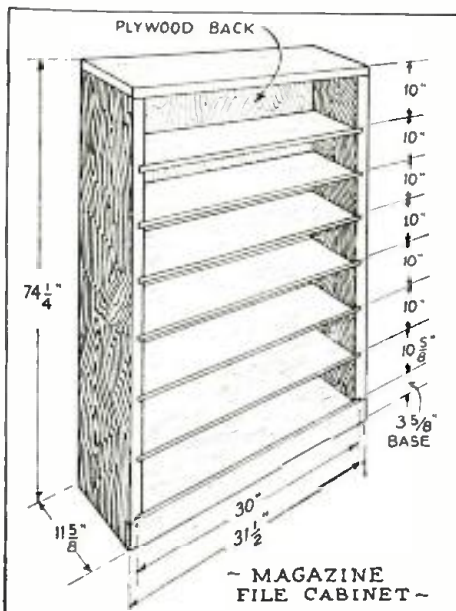

Fig. 4  
Wiring for ant., g'nd., and power supply outlets.

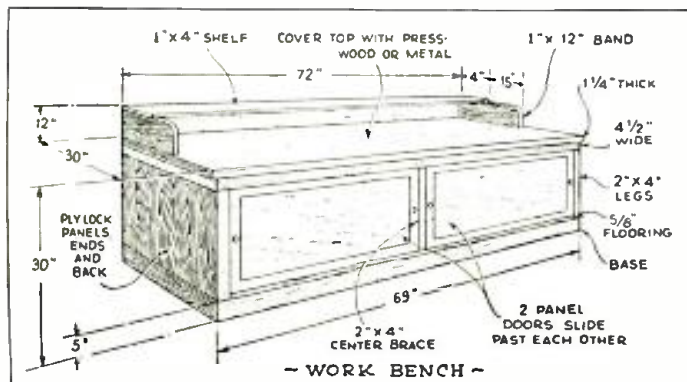
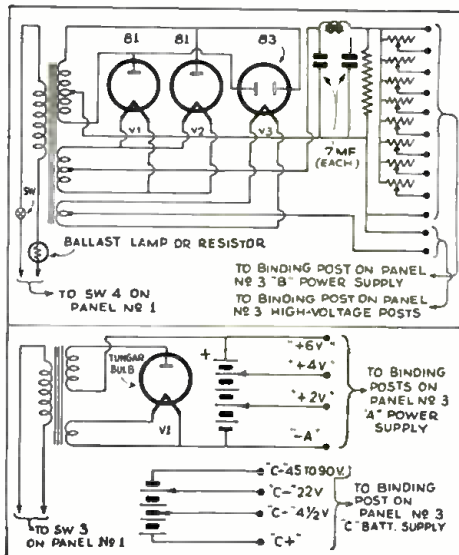

Fig. 1, left. Construction and dimensions of work bench.

Fig. 2, above. Dimensions for a magazine file rack.

Fig. 3, right. Diagrams of "A" and "B" power supply units.



# SHORT-CUTS IN RADIO

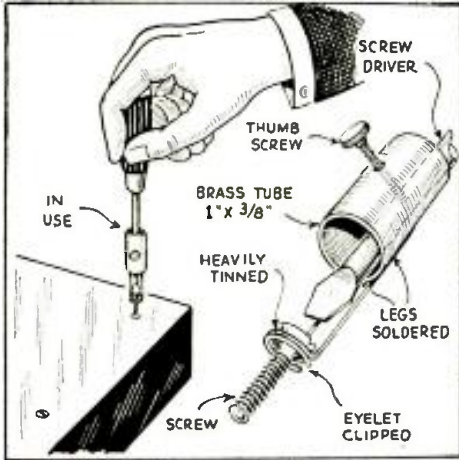

**A** SIMPLE screw- or bolt-holding attachment. It is sturdy, and easy to make and use. You need only a safety pin and a brass tube. Snip the latch, bend the eyelet at right-angles, and solder the legs to the tube (with the eyelet 1 in. away). Clip out the back of the eyelet.—B. O. BASS

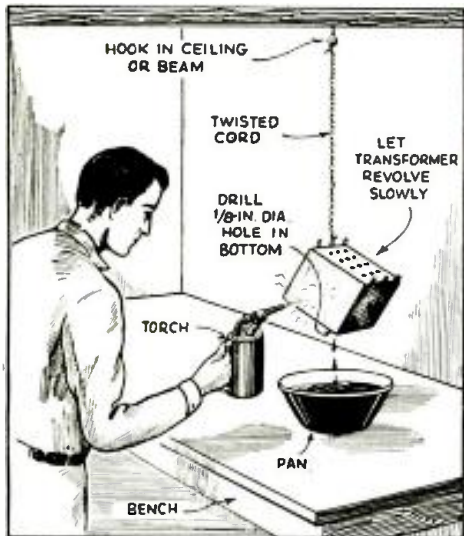

**A** CLEAN way to remove condenser and transformer compound. Drill a  $\frac{1}{8}$ -in. hole in a corner of the can, which is then suspended by a twisted cord (to maintain even temperature) about 12 in. above a drip-pan. Use a regulation blowtorch to bring the compound to the melting point.—CLIFFORD H. LANE

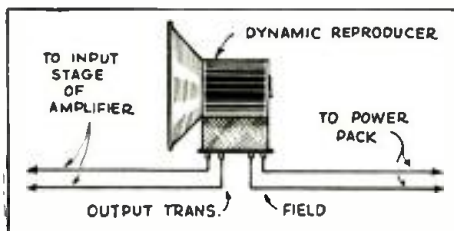

**A** N ORDINARY, small dynamic unit (for best quality) is connected as a microphone; talk across the diaphragm. A switch connects the output transformer to the A. F. system input or output.—DENNIS DELANEY

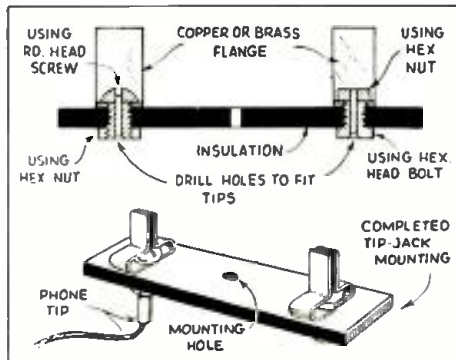

**H**OME-MADE tip-jacks are illustrated. Cut a piece of sheet metal to size,  $\frac{1}{4}$  x 2 ins., drill for screw or bolt, and bend as shown. Drill lengthwise through the bolt or screw a hole suitable for the plug.—JOHN BOUZIK

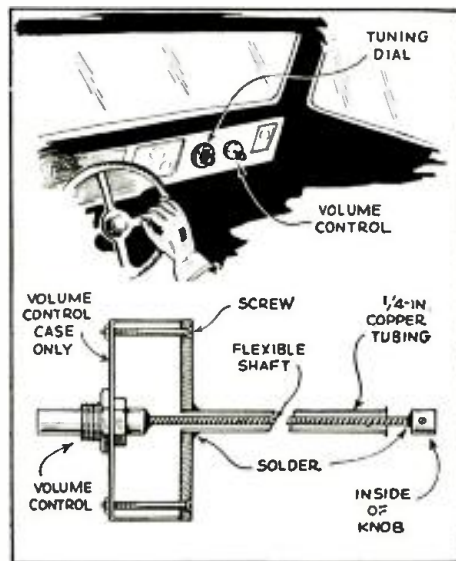

**M**AKE your own auto-radio remote control. Remove wiper and resistor from a volume control unit and fasten to the case a metal plate to which is soldered a copper guide tube. Solder a flexible shaft to the volume control shaft and to the opposite end of the flexible shaft solder a dial collar and set-screw. Use "hard" solder.—O. E. PAYNE

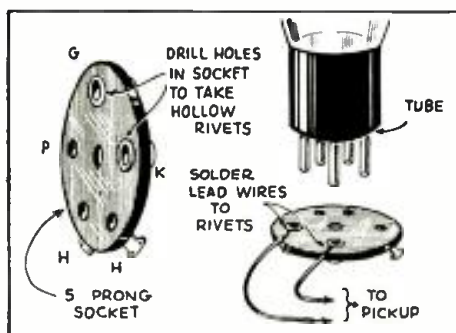

**A** N EMERGENCY phonograph pickup adapter was made by eyeletting a 5 prong socket, after removing the cathode and grid contacts and drilling the holes larger to accommodate hollow rivets.—VERNON ADAMS

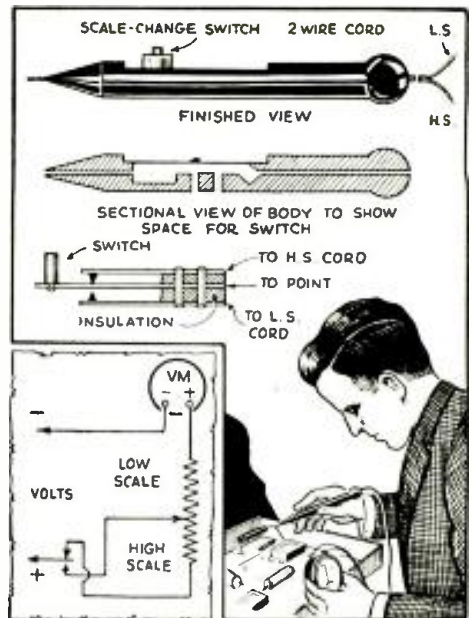

**A** SCALE-CHANGING test prod. Especially suitable in point-to-point resistance tests, to quickly secure the correct meter range. Merely mount a jack and push-button in the case of an ordinary expel-repel pencil, as shown.—MILLON C. ATWOOD

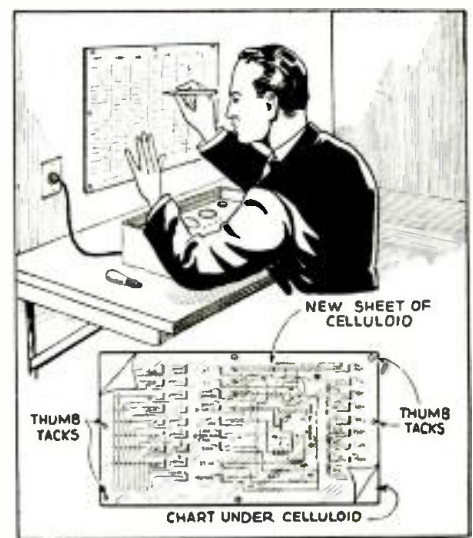

**C**ALIBRATION charts and reference material may be kept in perfect condition for immediate reference by mounting the data on a piece of wood or cardboard, covering it with a sheet of transparent automobile curtain. Hold the data and cover-sheet in place with thumb tacks.—J. A. CARGILE

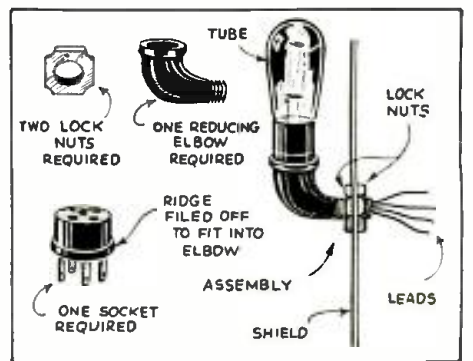

**A** GOOSENECK socket for panel amplifiers and transmitters. The reducing elbow and two lock-nuts for same are plumbing fittings. Solder leads to the socket before sealing into the elbow.—MARK EWALD



## NOTICE:

Mr. Experimenter—what is your idea of time- or money-saving ideas? Most radio men have a great number of short-cuts that they employ in their daily work—short-cuts that speed up their work or save them considerable cash. Sometimes the convenience these impromptu artifices afford is invaluable.

RADIO-CRAFT will pay, upon publication, space rates for ingenious expedients in radio—and its allied fields.

The items may include ideas in radio reception; photoelectricity; television; electronic music; radiodynamics; and public address.

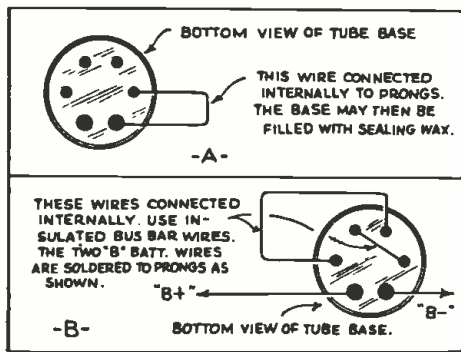

Fig. 1

Operating A.C.-D.C. sets on batteries.

## OPERATING A.C.-D.C. SETS ON A STORAGE BATTERY

Alden A. Rovs

IN FIG. 1 is shown, at A, an arrangement for operating the DeWald Standard model LW-4 A.C.-D.C. receiver from a 6 V. storage battery and "B" batteries; the adapter shown at B is designed to permit the Dual-Wave model LW-4-DW set to be operated under the same conditions. Both of these ultra-midget set models incorporate the types 6C6, 6D6, 43 and 25Z5 tubes; for battery operation the type 43 tube is replaced by a type 41.

Although there is available on the market a special plug and cable for connecting the radio set, by means of terminal connections at the rear of the set, for car operation, the plug must be removed every time it is desired to turn the set off, an operation which the kink, illustrated, makes convenient merely by operation of the regular set switch.

After making up the adapter shown at A, which utilizes a 6 prong tube base, remove the 25Z5 rectifier and replace it with the adapter. To connect the power cord to the "A" battery the writer has made up another adapter from an ordinary double-prong receptacle from which two leads run to heavy battery clips.

The Dual-Wave model incorporates a 6 prong auto socket. The special plug and cable for operating this set uses a 6 prong base connected as shown at B, for off-on operation of the set without removing the plug.

## A SUPER-SELECTIVE WAVETRAPH

Carroll Moon

AFTER time and the elements had wrecked the primary coil in the first I. F. stage in a G.E. model T-41, the receiver refused to function. Inasmuch as the designer of said outfit considered it a faux pas to leave any part of the chassis available, the primary was simply disconnected and the aerial connected to the grid-end of the secondary in the first R.F. stage. As a result the set worked beautifully, but tuned as broad as the dial would permit!

After some investigation of the problem a wave-trap suggested itself. No data was available and after several attempts, a honeycomb coil of 200 turns, shunted by a 500 mmf. variable condenser was inserted in the aerial lead. Results were "just fair."

After much experimenting the wavetrapp circuit shown in Fig. 2 was evolved.

Coils A and B, spaced 1/4-in., consist of 35 T. each of No. 24 S.C.C. wire wound in the same direction on a coil form 2 1/2 ins. in dia. The author used as condenser C a unit of about 800 mmf. or about 35 plates; an old 45 plate would work even better.

As originally designed the wavetrapp is effective from 700 to 1,500 kc. and then acts more in the manner of a band-selector. Once a station is tuned in on the main dial, the condenser C is varied until at one spot the volume of the incoming signal nearly doubles.

## ASSEMBLING SPEAKER CONES

Ernest Folta

IN PAST issues of RADIO-CRAFT there have been described ways and means of constructing speaker cones. However, none of the systems described a way to completely assemble a cone if the old

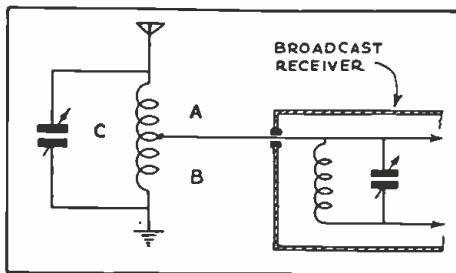

Fig. 2

A wavetrapp for super-selectivity.

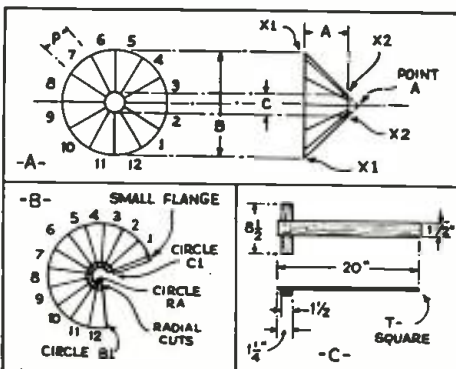

Fig. 3

How to make your own speaker cones.

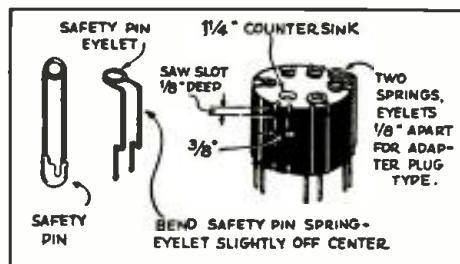

Fig. 4

Making adapters to order.

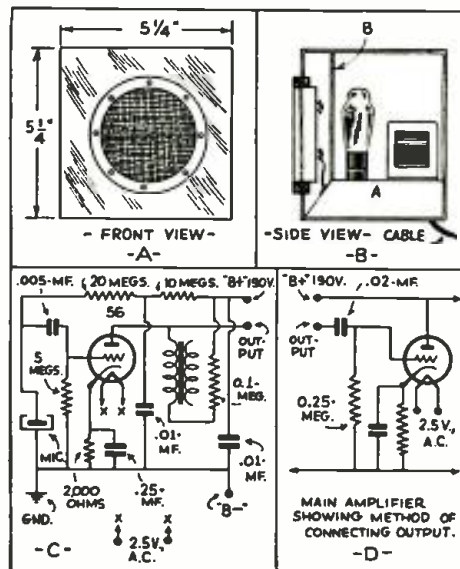

Fig. 5

A home-made condenser-mike adapter.

one could not be obtained, or if it was in such bad condition that an outline could not be drawn around its edges so as to facilitate its construction. It is the purpose of this article to show simple and elementary data concerning the construction of cones.

All of the materials needed can be bought in your local stationery store. The cost of these materials, listed below, should not exceed 50c. Assuming, for instance, that the voice coil and the spider are intact remove the entire assembly, being careful not to injure the voice coil windings. With everything out of the way we take our measurements.

First measure the cone's outside diameter, B, in Fig. 3, and scribe a circle having this diameter. Now measure the voice coil openings. (If the cone is cemented to the inside of the voice coil, take the inside measurements. If, as in most cases, it is cemented to the outside of the voice coil take the outside measurements.) This dimension is C in Fig. 3.

To take measurement A it is necessary to measure the distance from the part of the voice coil form where the cone was originally cemented, to the edge of the leather holding the cone to the frame. An easy way to do this is to get a piece of cardboard large enough to cover the face of the speaker. Through the center of this stick a pencil or a thin rod until it reaches the pole piece in the center of the voice coil. The length of rod running into the speaker is dimension A.

(Continued on page 55)

# THE ANALYSIS OF RADIO RECEIVER SYMPTOMS OPERATING NOTES

## COLIN B. KENNEDY 62

A RECEIVER was brought in similar to the Colin B. Kennedy Model 62 Superheterodyne (A.V.C.) with the exception that it didn't have a tuning meter. Volume was fair but the distortion was awful. After checking over voltage and current readings I located the trouble as a short-circuit between the primary and the secondary of the input transformer to the 47's in push-pull, placing a positive bias, about 20 V., on the grids of the type 47 power amplifiers. A new input transformer, T1, in Fig. 1, remedied this fault.

## SONORA D-70

THE coupling condenser, C, in Fig. 2, in the resistance-coupled stage of the Sonora D-70 may start to leak when the receiver has become thoroughly warm after running about 15 minutes. The speaker's voice or the music will sound muffled. A man or woman talking will sound as if their mouth was full of hot coffee and they were trying to converse at the same time. The D.C. rating of these condensers seems to be low for this particular position, most of them being of the cartridge type, pig tail ends, sealed with black pitch which becomes quite soft in a poorly ventilated cabinet (midgem models). The capacity of these particular units was .05-mf.—200 V. D.C.

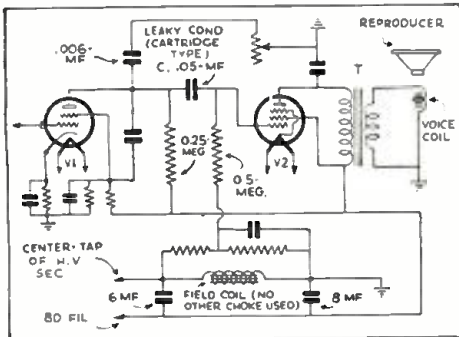

Fig. 2  
Muffled reception in a Sonora D-70 was corrected by replacing a leaky coupling condenser.

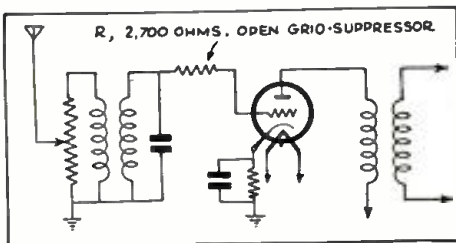

Fig. 4  
Lack of signal reception over part of the tuning range in a Kolster model CK-35 receiver was found to be due to an open grid-suppressor.

## WESTINGHOUSE 90

A STUBBORN case of intermittent reception was encountered in a Model 90 Westinghouse superheterodyne using type 27 tubes throughout with the exception of a single 45 in the output stage. Shunted across the first filter choke, in Fig. 3, is C, a .04-mf. 400 V. rating condenser, making a tuned filter system. This condenser is enclosed in a small, flat metal case soldered to the underside of the power pack unit which in Westinghouse models of this type is a separate unit installed on a shelf beneath the chassis, as is the dynamic speaker. The condenser unit was unsoldered from the chassis (the condenser was shorting occasionally), and reception became normal; installing a new unit completed the job.

In another model of the same set I just clipped off the two leads to this unit and reception became normal, with no noticeable increase in hum.

Unless the capacity of filter tuning unit C is exact it will be ineffective.

## 200 A ROGERS BATTERYLESS

AN ANNOYING, popping noise was cleared up in a Model 200 A Rogers batteryless receiver, console model. The rotor and the stator plates of one section of the 3 gang condenser had been

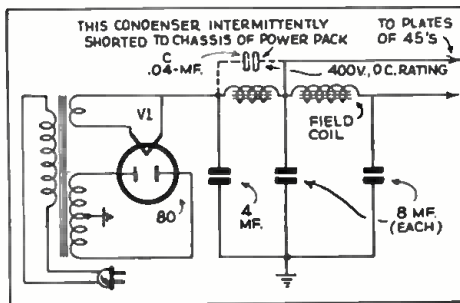

Fig. 3  
A Westinghouse 90 had a faulty choke-tuning unit.

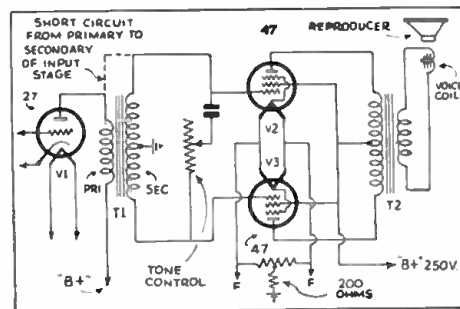

Fig. 1; Fig. 5, right  
Above—Replacing T1 repaired a Kennedy 62. Right—faint reception in a Mohawk Lyric model 90 chassis was traced to an open A.F. transformer in the "double push-pull" unit.

## WHAT THIS DEPARTMENT IS FOR

It is conducted especially for the professional Service Man. In it will be found the most unusual troubles encountered in radio service work, written in a practical manner, by Service Men for you.

Have you, as a professional man, encountered any unusual or interesting Service Kinks that may help your fellow workers? If so, let us have them. They will be paid for, upon publication, at regular space rates.

bent out of place when undergoing alignment at the factory, presumably. After being in use for some time, due to the wear in bearings and vibration from the large, ram's horn type speaker beneath the chassis, the plates of the sections would momentarily touch when the dial was turned to a certain few points. Bending the offending plates back slightly and re-aligning the set cured this.

## PHILCO MODELS

IN A number of Philco models made in Canada I have found that the push-back hook-up wire used has been drawn too tightly around the edges of projecting condenser cases, socket terminals, long bolts to the upper side of the chassis, and padder and trimmer condenser units. In time these cut through and cause the wire to short to the chassis, in a number of cases allowing faint reception, if any, depending on what part, the offending circuit wire was affecting. Tape around the defective spot will cure the trouble.

(Continued on page 61)

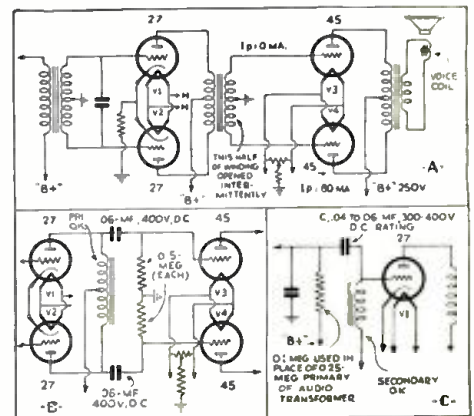



# RADIO-CRAFT'S INFORMATION BUREAU

## 25Z5 VERSUS 1V

(266) Mr. Everett E. Collins, Capron, Ill.

(Q.1) Please publish the answers to the following questions: Is a 1V tube as efficient a rectifier as a 25Z5 in an A.C.-D.C. set?

(A.1) The efficiencies of these two tubes cannot be compared in as simple a manner as you seem to think. The 25Z5 is actually two half-wave rectifiers in one glass bulb, which permits this tube to carry just twice as much current as the 1V. However, this does not indicate that the former tube is more efficient, as the filament and other characteristics are entirely different.

In other words, the tubes are not interchangeable. The 25Z5 has a filament designed for 25 volts, while the 1V requires 6.3 volts. Also, the 25Z5 is designed for a number of circuit variations, such as voltage doubling, etc., while the 1V is limited to use as a half-wave rectifier.

We would not suggest that you try to change the rectifier tube in your set to use the 25Z5, if it was designed for the 1V.

(Q.2) Could you publish a 6 volt battery converter of the vibrating type to operate this set from a 6 volt storage battery.

(A.2) While a 6 volt converter could be made to operate this set, this is not economically possible, unless you change the filament circuits of the tubes to a parallel connection, so that the filaments can be actuated directly by the storage battery, while the vibrator unit simply supplies the plate current.

## A SMALL P.A. SYSTEM

(267) Mr. J. Harworth Giraut, St. Louis, Mo.

(Q.) I have recently seen advertisements about a small P.A. unit which is self contained, having the speaker built right in with the amplifier and using a circuit which permits operation on either A.C. or D.C. lines.

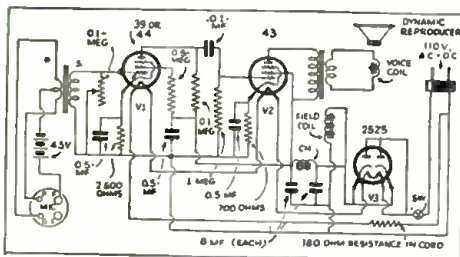

Fig. Q.267

An A.C.-D.C. P.A. system supplying 2 W. output.

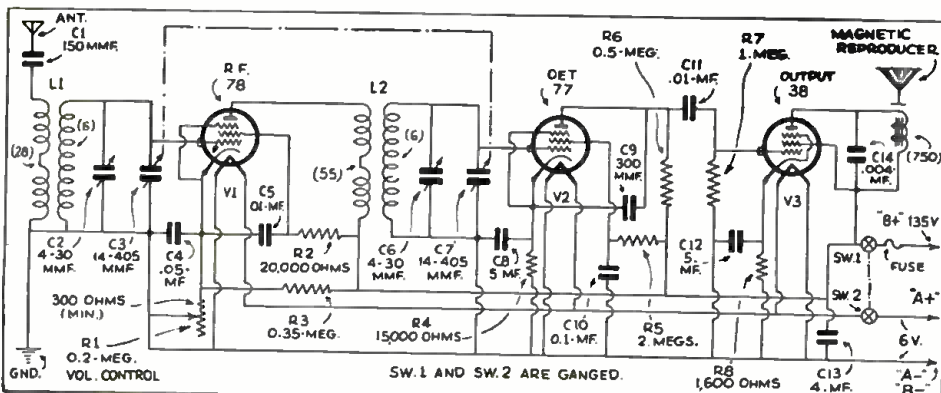

Fig. Q.269

The circuit of the General Electric model C-30, storage-battery operated receiver.

I have need for such a small unit, as I can rent one to stores in my neighborhood for advertising purposes. However, if possible I would like to build the unit, as I have a large stock of parts in my shop.

Can you supply me with the circuit of a suitable amplifier system of this type?

(A.) The circuit shown in Fig. Q.267 should answer your requirements. As you will notice, it uses a double-button carbon mike, for high quality, coupled to a type 39 or 44 pentode tube which is, in turn, coupled to a type 43 power pentode tube. Resistance interstage coupling is used for stability and to permit the high voltage gain of the two pentode tubes to be utilized.

The filaments of the two amplifier tubes are connected in series with the 25 V. filament of a 25Z5 rectifier tube, which serves the double purpose of supplying the plate voltage of the amplifiers and supplying the field coil of the dynamic speaker.

The values of all resistors, condensers and other parts are specified on the circuit. We are sure that you will have little difficulty in constructing the unit. However, there are several precautions to be observed.

The carbon microphone must not be used too close to the amplifier, for it must be remembered that the reproducer is in the same case as the amplifier, and you will be troubled by acoustical feed-back if the two are placed too close together. The dynamic reproducer should have a field winding designed for operation on 110 V.D.C. and the output transformer, which is usually attached to the speaker should be designed to operate from a power pentode of the type used.

It will be noticed that a power cord having an internal resistor is used. This type of cord becomes warm during operation—this heating is normal and does not impair the operation of the unit in any way.

## SECONDARY EMISSION AND THE DYNATRON

(268) Mr. H. A. Irvine, Winnipeg, Man.

(Q.) As a constant reader of RADIO-CRAFT, I naturally turn to you for information about a subject which I have little or no knowledge namely, secondary emission.

What is the effect of carbonized plates in dynatron oscillators or oscillators combined with first-detectors using a 24 type tube?

(A.) Secondary emission from the plate of a tube; or any of the grids, is due to the impact of electrons from the filament expending sufficient energy when hitting the plate to knock other electrons from it. It is these "other" or secondary electrons that

give rise to secondary emission effects. It is these same secondary electrons which cause the rather erratic curves in the type 24 tubes at low plate voltages which, incidentally, makes them suitable for dynatron action.

Carbonizing the plates of these tubes reduces the number of secondary electrons from the plate and hence minimizes the curvature of the tube characteristic which is used for dynatron oscillators. For this reason, type 24 tubes with carbonized plates are not particularly suitable in dynatron circuits.

For further details regarding the dynatron action, the article "Facts About Dynatron Operation," by C. M. Delano, in the March 1934 RADIO-CRAFT, page 535, and April 1934, page 598, should be read.

## A STANDARD BATTERY SET

(269) Mr. Erach, New Haven, Conn.

(Q.) I have a cabin at Lake Sebago, Maine, which I visit every summer for vacation. Several years ago, I took a radio set up there, but did not get very good results, mainly because the 2 V. tubes were used and they were found to be too delicate. We experienced too much trouble with burned out tubes, which were both expensive and difficult to obtain up there.

I have been thinking of building a set using the 6.3 V. type tubes and use a storage battery for filament supply. While we do not have electric-light lines in the cabin, there is an automobile service station about a mile away where the battery can be charged. Can you supply the circuit for a dependable three tube battery operated set of the type desired?

(A.) The circuit at Fig. Q.269 is both simple and dependable. In fact, as you can see, it consists simply of a stage of T.R.F. using an R.F. pentode tube, a screen-grid detector and a power pentode A.F. amplifier.

While this layout may not seem sufficient for dependable reception, it must be remembered that all of the tubes have high amplification factors and the resulting volume and sensitivity will be a surprise to you. The circuit shown is identical with that used in the General Electric model C-30 table model battery-operated receiver.

In constructing the set, we would advise you to purchase the coils, one of which is (Continued on page 47)

## SPECIAL NOTICE

Those questions which are found to represent the greatest general interest will be published here, to the extent that space permits. (At least 5 weeks must elapse between the receipt of a question and the appearance of its answer here.) Mark such inquiries, "For Publication."

Replies, magazines, etc., cannot be sent C.O.D. Back issues of RADIO-CRAFT prior to December, 1932, are available at 50c per copy; except the following issues: 7/'29, 2, 3, 4, 6, 9 and 11/'30; 5, 8 and 9/'31; and 10/'32, which are out of print. Succeeding issues are still available at the regular price of 25c per copy.

Inquiries to be answered by mail MUST be accompanied by 25c (stamps) for each separate question; answers are subject to subsequent publication if considered of exceptional interest.

We cannot furnish individual design considerations.

Furnish sufficient information (in reference to magazine articles, be sure to mention issue, page, title, author and figure numbers), and draw a careful diagram (on separate paper) when needed to explain your meaning; use only one side of the paper. List each question. Be SURE to sign your name AND address.

Enclose only a STAMPED and self-addressed envelope for names and addresses of manufacturers; or, in connection with correspondence concerning corrections to articles, as this information is gratis.

GENERAL ELECTRIC "AUTO AND HOME" MODEL B-52 5 TUBE SUPERHETERODYNE

(Portable, "arm rest" home and car radio set. Incorporates a dual rectifier system—a synchronous vibrator mechanism of full-wave type for battery operation, and a tube rectifier for 110 V., A.C. power line operation. Also has A.V.C., tone control, and sensitivity switch.)

Ultra-modern in every sense, the new G.E. model B-52 receiver, illustrated both inside and out, as well as schematically, establishes a new standard of utility. Use it at home, plugged into the wall receptacle for 110 V., A.C. power, or take it out to the automobile and connect its battery socket to a permanently installed battery power cable. The maximum undistorted output rating of the set is 1.8W. (maximum, 3.6 W.) with a power line consumption of only 50 W.; the battery drain is only 3.7 A.

Tube Type	Plate Volts	Cath. Volts	S.G. Volts	Cath. Ma.
V1	216	4.2	86	5.5
V2*	216	4.2	86	10.0"
V2**	216	4.2	—	10.0"
V3	207	2.7	87	4.5
V4	235	15.0	255	30.0
V5	325	—	—	30.0

The above tube operating voltages are taken with a 115 V., A.C. line or 6.3 V. battery supply; and with the set adjusted for "no signal" conditions with the sensitivity control at "sensitivity."

\*Det. 1; \*\*osc.; 'r.m.s.; 'total.

The tuning range of this set is 540 to 1,500 kc. Note that the vibrator inverter-rectifier is accurately adjusted and sealed at the factory and service adjustment should not be attempted. The resistance values of inductances are shown in parentheses.

The power circuit for battery operation consists of the vibrator inverter-rectifier with its associate transformer and filter circuits. The heaters of the tubes are powered directly from the car storage battery. The operating switch is so arranged that at one position battery operation is obtained, while at the other position, correct connections are made for A.C. operation.

When the switch is in the A.C. position, the A.C. input current is connected to the primary of P.T.2. Two secondaries are provided, one for furnishing power to the tube filaments and the dial lamp, and the other for plate supply to V5. The output of V5 utilizes the same filter system as that required in battery operation; the field coil is used as a filter choke.

Adjustment of the R.F. section of the set is made in the following manner. First, align the dial pointer to the low-frequency end graduation (small arrow marked "Max. Cap."), with tuning condenser rotor fully meshed. Next, turn dial to 140, couple a service oscillator to the antenna and ground posts, and adjust the output meter (connected across the voice coil) for maximum deflection at 1,400 kc. Correct circuit interlocking by making a second re-alignment.

In making I.F. adjustments connect the service oscillator between the control-grid of V2 and ground; the output meter remains connected to the voice coil. Reduce the output of the service oscillator until only a small deflection of the output meter is obtained, in order to counteract the A.V.C. action, with the volume control set at maximum. Also, ground the antenna lead and adjust the tuning condenser so that only the service oscillator signal can be heard. Then, adjust the I.F. trimmers for maximum deflection of the output meter. Although it is advisable to follow the I.F. adjustments by R.F. alignment, due to interlocking effects, the reverse is not always true.

STATIC INTERFERENCE

Few Service Men realize that various clicking sounds heard via the radio set only when the car is in motion may be evidence that "static electricity" is being generated by friction. Test by coasting down a hill with the motor turned off.

(1) Eliminate static electricity generated by friction between the brake drum and the brake lining by applying "brake juice" to the brake lining.

(2) Eliminate static due to friction between the tires and the road surface by attaching a small brass brush under the retaining nut on the spindle to contact the wheel hub or cap; or, mix a teaspoonful of graphite grease with the front-wheel grease (rear wheels usually make good contact through the rear driving axles).

(3) The rims of wooden wheels, especially those equipped with balloon tires, may require bonding to the hub; and the hub may require grounding to its spindle by using graphite grease.

(4) In some cases brake drums, rim, and spindle must be bonded together. Trouble due only to friction between the brake drum and the brake lining, may often be cleared by bonding the brake rods—which act as an antenna and re-radiate the noise—to the chassis of the car. (Static interference data courtesy Hygrade Sylvania Corp.)



The external appearance of the "arm rest" set.

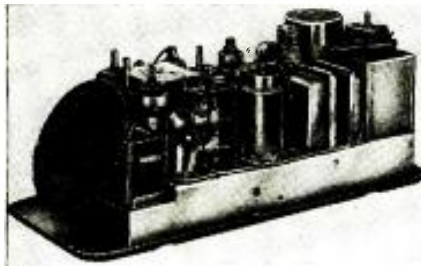

The compact assembly of the set is evident.

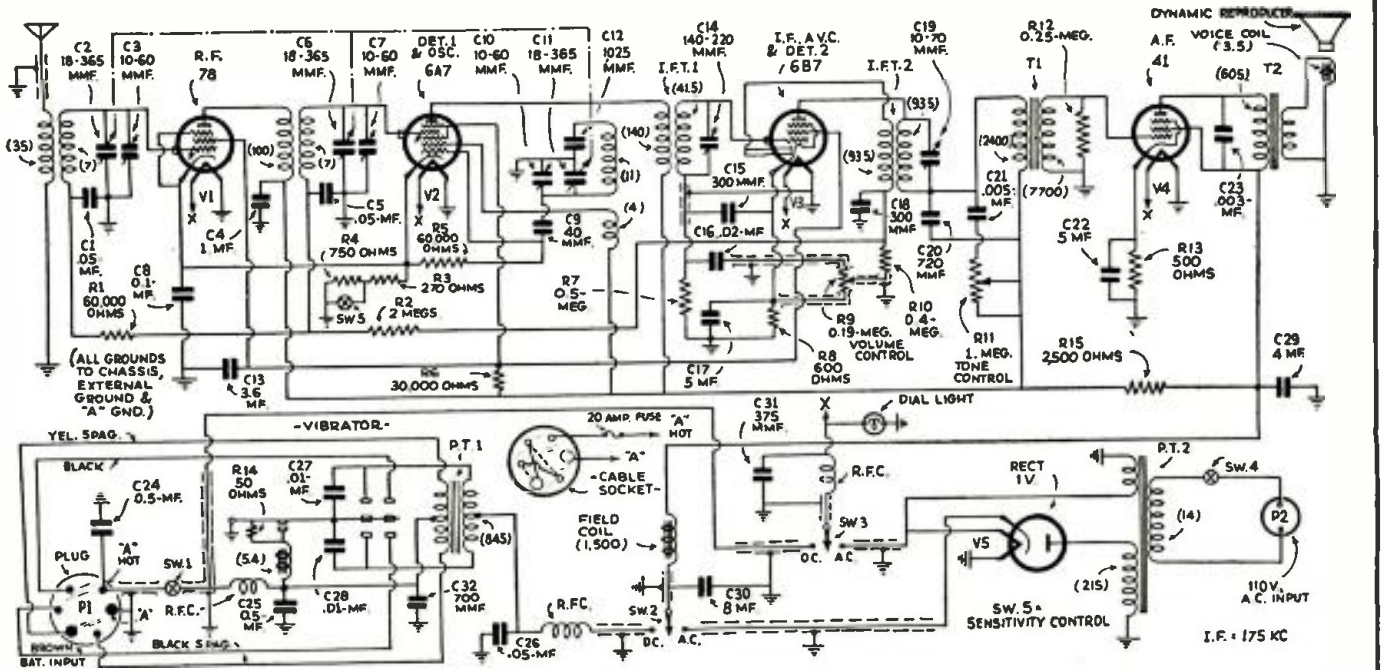





**\$3.50**

Reg. List Price

400 Pages  
Over 2,000 Illustrations  
9 x 12 Inches  
Flexible, Looseleaf  
Leatherette Cover

## There's plenty of Servicing Material in the **NEW 1934 Manual**

**T**HE necessity of GERNSBACK Manuals in the radio field has been shown by the fact that the total sales of the first three OFFICIAL RADIO SERVICE MANUALS, including the new CONSOLIDATED EDITION, now exceed 80,000 copies. Radio Service Men and others engaged in various branches of radio know the importance of such books, and how they must depend upon them for reliable information. Whether for public-address work, tube information or a circuit diagram, the material needed is certain to be found in one of the OFFICIAL RADIO SERVICE MANUALS.

In preparing this new edition many of the outstanding problems of the Service Men have been considered—methods of servicing, the new equipment constantly needed to cope with new tubes and sets, and the other fields of radio, such as public-address systems, short waves, auto radio and others.

The illustrations in the 1934 Manual are more explicit than before; inasmuch as the diagrams are not limited to the schematic circuit, but other illustrations show the parts layout, positions of trimmers, neutralizers, etc. There are hundreds of new circuits included, and not one from any previous editions of the manuals has been repeated. *This we unconditionally guarantee.*

As in previous years, the 1934 Manual also includes a FREE QUESTION AND ANSWER SERVICE. In each book will be found 25 coupons, which entitle you to free consultation on any radio service topic. These coupons give you a complete mail service—questions on servicing and operating any set or circuit are answered promptly and accurately by the editors. Remember that, at the regular rate of 25¢ per question which is usually charged by radio magazines, this service alone is worth \$6.00. And for the Manual, we charge only \$3.50.

It is quite evident that the 1934 Edition of the OFFICIAL RADIO SERVICE MANUAL is a decided improvement over previous volumes.

### ORDER YOUR COPIES NOW

It is important to every Radio Service Man and Dealer to get his copy of the 1934 OFFICIAL RADIO SERVICE MANUAL now. The new book will prove itself to be invaluable as those volumes of previous years.

No need to delay sending us your order—the 1934 MANUAL, like its predecessors, is a necessity in your business. We strongly advise you to order your copy today.

**GERNSBACK PUBLICATIONS, INC.**  
99 Hudson Street New York, N. Y.

### Contents of the 1934 Manual in Brief

- Diagrams and service notes, more complete than ever before in any MANUAL. Not merely the schematic hook-ups will be found, but chassis drawings showing parts layouts, positions of trimmers, neutralizers, etc.
- Voltage readings for practically all sets, as an aid in checking tubes and wiring.
- All values of intermediate-frequency transformers used in superheterodynes, with the manufacturers' own suggestions as to correct balancing.
- Detailed trouble-shooting suggestions and procedure as outlined by the manufacturers' own engineers—in other words, authentic "dope" right from headquarters.
- Values of all parts indicated directly on all diagrams.
- Section for reference to A.C.-D.C. cigarbox midjets.
- Section for reference to public-address amplifiers.
- Section for reference to short-wave receivers.
- Section for reference to remote-control systems.
- A complete compilation of radio tube data, covering both the old and the many new types.
- Section devoted to test equipment, analyzers, etc., with full diagrams and other valuable information.
- A complete list of American broadcast stations with their frequencies in kilocycles; extremely useful in calibrating and checking test oscillators and in calibrating receivers.
- Free Question and Answer Service, the same as in our last two Manuals.
- No theory; only service information in quickly accessible form.
- Absolutely no duplication of any diagrams; nothing that appeared in any of the previous Manuals will appear in the 1934 MANUAL. This we unconditionally guarantee.
- A handy, easily-consulted master index making it easy for you to find almost anything pertaining to your service problem instantly. This index includes all the diagrams published in all the previous GERNSBACK Manuals, as well as the 1934 diagrams. A big convenience and time saver!

### Clip—Mail This Coupon Today

GERNSBACK PUBLICATIONS, Inc.  
99 Hudson Street, New York, N. Y.

Gentlemen: Enclosed you will find my remittance of \$3.50 for which you are to send me. Postage Prepaid. One Copy of the 1934 OFFICIAL RADIO SERVICE MANUAL. [Send remittance by check or money order; or register letter if it contains cash, currency or unused U. S. Postage stamps.]

Name .....

Address .....

City ..... State .....

RC-734

USEFUL AUTOMOTIVE-RADIO REFERENCE INFORMATION

(A compilation of valuable data, for speeding auto-radio service work, which includes: intermediate frequencies in foremost car-radio superhets.; the polarity of the storage battery's grounded lead; where to find the lead-in in cars equipped with antennas, and; the type of roof in cars unequipped with an aerial system.

INTERMEDIATE FREQUENCIES IN AUTO-RADIO SUPERHETS

Manufacturer	Model	I.F. (Kc.)
Aero-Charles Hoodwin Co.	970	175
Air King Products Corp.	400, 500	175
All-American Mohawk Corp.	U-500	485
All-American Mohawk Corp.	U-500	456
American Telev. & Radio Corp.	Duo, 61	175
Arvin-Noblitt Sparks Industries	10-A	175
Arvin-Noblitt Sparks Industries	20-A, 30-A	182½
Atwater Kent Mfg. Co.	91, 91-B, 91-C	200
Atwater Kent Mfg. Co.	421, 666, 816, 926, 936	264
Atwater Kent Mfg. Co.	531	450
Atwater Kent Mfg. Co.	636, 756, 756-B	262½
Audiotra Radio Co.	6, 7, A-6, 8-7	177½
Audiotra Radio Co.	315	456
Autoerat Radio Co.	Dictator 5	456
Auto-Vox Radio Co.	75	175
Auto-Vox Radio Co.	292	262
Belmont Radio Corp.	660	175
Cadillac Motor Car Co.	66W, 672, 56V1	262
Caruso-Laurelh Radio Co.	AE-79	175
Central Radio Corporation	560, 561	256
Central Radio Corporation	261	175
Crosley Radio Corporation	95, 96, 98, 102, 103	181½
Colonial Radio Corporation	150	480
Colonial Radio Corporation	106B, 161, 161B, 182, 182B	175
Delco Radio Corporation	3026	175
DeWald-Pierce Auto Inc.	61	456
DeWald-Pierce Auto Inc.	52	175
Electric Auto Lite Co.	062-A, 072-A, 3722	262
El Rey Radio Mfg. Co.	A, B, C	465
Emerson Radio & Photo. Corp	678	172½
Erla-Elect. Research Labs.	521	175
Erla-Elect. Research Labs.	601, 602, 5600, 6000	265
Erla-Elect. Research Labs.	4100	370
Fada Radio & Electric Corp.	101(RK), 102, 104-B	175
Fada Radio & Electric Corp.	104	470
Franklin Radio Corp.	100, 102, 200	175
Freed Radio & Television Corp.	A-7, A-9	456
Gulbransen Company	362, V622, 66-W, Z621	262
Jackson-Bell Company, Ltd.	21, 205	456
Kayo Manufacturing Co.	Super 1	175
Kayo Manufacturing Co.	Super 5	262½
Larkin Company	90, 91	175
Lytic, Rudolph Wurlitzer Co.	A-60	485
Lytic, Rudolph Wurlitzer Co.	466	175
Majestic-Grigsby Grunow Co.	66, 111, 116	175
Melburn Radio Mfg. Co.	40, 15, 50	465
Missouri Bell Radio Co.	10-A, 19, 19-A	262
Montgomery Ward Co.	670	175
Motorola-Galvin Mfg. Co.	7-T-17-A, 61, 88	175
Motorola-Galvin Mfg. Co.	11, 55, 66, 77, 77A, 77B	156
Moto-Meter Gauge & Equip. Co.	10-A	175
Packard Radio Corp.	5, 46	470
Philco Radio & Tele. Corp.	5	160
Philco Radio & Tele. Corp.	7, 8, 12	175
Philco Radio & Tele. Corp.	6, 9, 10	260
RCA Victor Company, Inc.	M30, M32, M34, M105, M116	175
Radio Chassis, Inc.	2, 3	175
Sparks-Wilmington Company	33, 31	172½
Stewart Radio Corporation	60	262
Stewart-Warner Corporation	R-112	456
Stranberg-Carlson Tele. Co.	33	260
Stranberg-Carlson Tele. Co.	(Compact Police)	175
Transformer Corp. of America	AR-100	165
United American Busch Corp.	100, 150, 108 (Police)	175
United Motors (BOP)	2035, 1036, 4037	262
Well-Gardner & Company	5V, 6V, 61, 662, 671, V622, 66-W	262
Wholesale Radio Serv. Co., Inc.	6-Tube Super	262
Zenith Radio Corporation	460, 161	185

CAR BATTERY GROUNDS AND ANTENNA DATA

Make of Car	1931			1932			1933			1934		
	A	B	C	A	B	C	A	B	C	A	B	C
Auburn	P	1	1	P	1	1	P	A	1A	P	—	—
Austin	P	—	—	P	—	—	P	—	—	P	—	—
Buick	N	1	3	N	1	3	N	2	—	N	—	—
Cadillac	P	3	—	P	3	—	P	3	—	P	—	—
Chevrolet	N	1	4B:5C	N	1	4B:5C	N	1	B	5C	N	1
Chrysler	P	4	—	P	4	—	P	4	—	P	5	—
Continental	—	—	—	—	1	6	N	1	6	N	—	—
Cord	P	1	1	P	1	1	P	—	—	—	—	—
Cunningham	N	—	—	N	—	—	N	—	—	N	—	—
DeSoto	P	4	—	P	4	—	P	5	—	P	—	—
DeVaux	—	—	—	N	—	—	—	—	—	—	—	—
Dodge	P	4	—	P	4	—	P	5	—	P	—	—
Dusenbergs	N	—	—	N	—	—	N	6	—	N	—	—
Durant	N	—	—	N	—	—	—	—	—	—	—	—
Essex	N	1	7	N	1	7	N	—	—	N	—	—
Ford	P	1	—	P	7	—	P	8	—	P	—	—
Franklin	P	1	8	P	18:9D	—	P	18:9D	—	P	—	—
Gardner	P	—	—	—	—	—	—	—	—	—	—	—
Graham	P	1	1	P	1	1	P	9G	—	—	—	—
Hudson	N	1	7	N	8	—	N	8	—	P	—	—
Hupmobile	P	—	—	P	—	—	P	—	—	P	—	—
Jordan	N	—	—	—	—	—	—	—	—	—	—	—
Lafayette	—	—	—	—	—	—	—	—	—	P	—	—
La Salle	P	3	—	P	3	—	P	3	—	3	—	—
Lincoln	N	10	—	N	10	—	N	10	—	N	—	—
Marmont	P	—	—	P	—	—	P	—	—	P	—	—
Nash	P	5	10	P	6	10E	P	7	8	P	9	—
Oakland	N	1	1	—	—	—	—	—	—	—	—	—
Oldsmobile	N	1	7	N	1	7	N	9	—	N	—	—
Packard	P	1	11	P	1	11	P	1	—	P	—	—
Peerless	P	—	—	P	—	—	—	—	—	—	—	—
Pierce-Arrow	P	J	—	P	K	—	P	K	—	P	—	—
Plymouth	P	8	—	P	8	—	P	8M:8	—	P	—	—
Pontiac	N	1	1	N	1	1	N	—	—	N	—	—
Reo	N	1N:12F	80	N	1N:12F	80	N	1N:12F	80	N	—	—
Rockne	—	—	—	P	—	—	P	—	—	—	—	—
Studebaker	P	8Q	—	P	9R	—	P	9	—	P	—	—
Stutz	N	1	13	N	1	13	N	1	13	N	—	—
Terraplane	—	—	—	8	—	—	8	—	—	P	—	—
Willys	N	—	—	N	—	—	N	—	—	—	—	—

COLUMN A—BATTERY GROUNDS

- (1) Positive ground in 1929 models.
- (2) Negative ground in 1929 models.
- (3) 6 has negative ground.
- (4) 1926 standard 6 and 1930 twin-ignition 6 have negative ground.
- (5) 630, 870 and 880 have negative ground.
- (6) 960, 970, 1060, 1070 and 1080 have negative ground.
- (7) 1120, 1130 and 1170 have negative ground.

COLUMN B—ANTENNA LEAD-IN

- (1) None supplied.
- (2) Left windshield post. Loose end behind cowl trim board.
- (3) Right header windshield pillar. On a few folding top models, lead is brought forward from rear of top by running beneath body.
- (4) Right pillar.
- (5) Department pillar.
- (6) Left front pillar on all closed models.

- (7) Left rear pillar.
- (8) Right front pillar.
- (9) Left front pillar.
- (10) Rear inside back of seat.
- (A) Models 8-101 and 12-161, none supplied; 8-105 and 12-165 left end windshield header.
- (B) Closed models: Left front pillar post; cabriolet; left side of dash.
- (C) Model CJ, right pillar on special order.
- (D) Late models, right pillar.
- (E) Late models DD, right pillar.
- (F) Model A, 1928 and 1929, none supplied.
- (G) Starting model 57-A, body No. 262 or chassis No. 1020638; model 46, body No. 262 or chassis No. 1801187; model 65, body No. 2857 or chassis No. 1007385.
- (H) Left center pillar.
- (I) Coiled back of right cowl trim panel.
- (J) Head-in brought down through window of left front door of closed bodies.
- (K) Lead-in brought down right rear quarter of top and back of seat cushion. (Remove seat cushion when making connection.)
- (L) Late models.
- (M) Early models.
- (N) Flying Cloud, all models (and 1929).
- (O) Royle, all models.
- (P) After July, 1930.
- (Q) After June, 1931.
- (R) After March, 1932.

COLUMN C—TYPE OF ROOF

- (1) Wood slat.
- (2) Slat and bow type diagonal X-type metal braces (not grounded).
- (3) Slat and bow.
- (4) Wood bows and slats.
- (5) Wood bows.
- (6) Padded fabric over wood bows.
- (7) Wood cross bows.
- (8) Insulated poultry wire.
- (9) Grounded poultry wire.
- (10) Poultry netting.
- (11) Wire mesh.
- (12) Poultry wire, usually grounded.
- (13) All roofs are slat type except Lebaron bodies, which have grounded poultry wire.
- (A) Models 8-101 and 12-161.
- (B) All closed models.
- (C) All open models.
- (D) Series 18.
- (E) Except models 1060, 1070, 1080 and 1090.
- (F) Flying Cloud (including 1929 model).

This Data Sheet has been compiled by RADIO-CRAFT staff from "Tube Complements for Auto Radio Sets," by RCA Victor Co., Inc., and; "Auto-Radio Installation and Servicing," by Hygrade Sylvania Corp.

SPECIAL NOTICE

Due to an oversight, authorship credit did not appear on Data Sheets Nos. 113 and 114, "Radio-Craft Table of Bias Resistor Values," May, 1934. These Data Sheets were compiled by Mr. Oscar Block.



# FLYING "BLIND" BY RADIO

(Continued from page 15)

side the case changes only gradually as the air leaks out (or in) through the leak tube; the difference in pressure is proportional to the rate of climb (or descent), and is registered on the dial.

The air speed is measured by a Pitot static head tube; but no direct reading of true ground speed is possible, as there is no way of measuring drift when flying "blind," except by taking radio bearings, and then computing the resultant. The sensitive altimeter operates on the aneroid barometer principle, and the reading is naturally affected by changes in barometric pressure; however, barometric pressure is broadcast from the ground stations, and knowing the difference in altitudes between the airports of departure and destination, and between barometric pressure at take-off and landing, very accurate adjustment is possible, although insufficient for the purposes of blind landing, which is made solely by radio. The traditionally uncertain magnetic compass is supplemented by a directional gyro, which is used principally for regulating the rudder control operating mechanism of the automatic pilot. The automatic pilot consists of the directional gyro and an artificial horizon, and regulates, through a mechanical follow-up system, the controls of the airplane, keeping it on any desired course, thus relieving the pilot from this exhausting task. But the problem of arriving at the invisible destination and landing at the fog-glutted airport is left to radio.

## The Radio Range Beacon

The backbone of blind aerial navigation is the radio range beacon. Eighty-one such beacons form a coast-to-coast net of invisible lanes. A typical radio range beacon is shown schematically in Fig. 2. Four directional antennas pour forth a continuous stream of signals: letter N (—) is always directed to the north and south quadrants, while the letter Δ (—) indicates the east and west quadrants. If the beacons run directly north and south, the N signal is in the north-west and southeast quadrants. By adjusting the transmitting antennas, it is possible to secure any desired direction of the zone where the — (dot-dash) and — (dash-dot) signals blend in one continuous note: this narrow zone of blending radio signals is the range "beam."

Reception of range-beacon signals is either aural or visual. In the instance of aural reception the pilot hears a steady audio-frequency note as long as he remains on course, the note changing to — (dot-dash) or — (dash-dot) if an incorrect allowance for wind or a compass error takes him off the path of the radio beam. Automatic volume control, to compensate for the increasing field intensity as the aircraft approaches the station, is provided, and can be cut into the circuit by the pilot once he ascertains his direction on a particular beacon by change in signal strength and his compass bearing. (At prescribed periods, the beacon signals are temporarily interrupted, and Federal weather broadcasts are made on the same frequency, thus enabling the pilot to "ride the beacon" and receive essential weather information without changing the dial setting.)

For visual reception of radio range beacons, the Morse signals of the aural system are replaced by two different modulations (65 and 80.7 cycles, or 75 and 100 cycles); the higher frequency of the combination taking the place of the N signal in the north and south quadrants. A vibrating-reed type of course-indicator is used for interpreting the signals (the oblong box underneath the landing beam course-indicator shown in photo of instrument board.) When on course, the tips of two rapidly vibrating reeds (one for either frequency) appear as two white lines of equal length, because of optical inertia. A deviation from the beacon path increases vibration of the reed on that side, and decreases the vibration of the other, making them appear as two unequal white lines, the longer white line indicating the side to which the airplane is off course.

**BING CROSBY**  
**CLEAR'S UP A MISTAKE**  
*—and gives a tip on clear radio reception*



ISN'T BING'S VOICE GRAND IN THE MOVIES?

AND JUST THINK—I'M GOING TO MEET HIM TOMORROW.

NEXT DAY—AT THE MOVIE STUDIO



## GET RADIO AT ITS BEST WITH MICRO-SENSITIVE RCA RADIO TUBES

THERE'S a new thrill in store for you when you replace old tubes with these new Micro-Sensitive RCA Radio Tubes. For true-to-life reception a radio tube must be sensitive enough to pick up a microscopic electrical impulse—the millionth part of a volt. RCA Radio Tubes give you "Micro-Sensitive" accuracy. Have your dealer test your tubes today. Replace worn tubes with the only tubes guaranteed by RCA Radiotron Co., Inc., to give these 5 big improvements:

- 1 Quicker Start
- 2 Quieter Operation
- 3 Uniform Volume
- 4 Uniform Performance
- 5 Every Tube is Matched



**RCA** **Lunningham** **Radiotron** **RADIO TUBES**



# AMERICA TURNS TO MIDWEST!



## AMAZING NEW

# Super Deluxe 16-TUBE ALL-WAVE RADIO

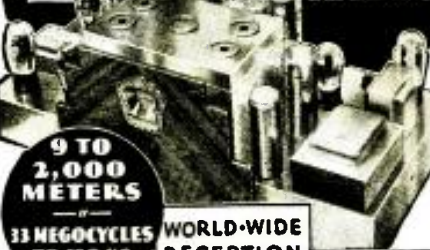

**9 TO 2,000 METERS**  
OR  
**33 MEGACYCLES TO 150 KC**  
**WORLD-WIDE RECEPTION**

**BEFORE** you buy any radio, write for big new FREE Midwest catalog printed in four colors. It has helped thousands of satisfied customers save from 1/3 to 1/2 on their radios . . . by buying direct from the Midwest Laboratories. You, too, can make a positive saving of from 30% to 50% by buying a Midwest 16-Tube Super Deluxe ALL-WAVE radio at sensationally low direct-from-laboratory prices. They bring in broadcasts from stations 10,000 miles and more away . . . and give complete wave length coverage of 9 to 2,000 meters (33 megacycles to 150 KC). These bigger, better, more powerful, clearer toned, super-selective radios have FIVE distinct wave bands. Ultra-short, short, medium, broadcast and long . . . putting the whole world of radio at your finger tips. Now listen in on all U. S. programs . . . Canadian, police, amateur, commercial, airplane, and ship broadcasts.

Try this Midwest radio for 30 days before you decide. New four-color catalog pictures a complete line of beautiful, artistic consoles and chassis. See for yourself the 40 new 1934 features that insure amazing performance. These features include Automatic Select-O-Band, Amplified Automatic Volume Control, 16 New Type Tubes, Balanced Unit Superheterodyne Circuit, Automatic Tone Compensation, 29 Tuned Circuits, 7 KC Selectivity, etc. These and many additional features are usually found only in sets selling from \$100 to \$150! Write for FREE catalog.

### DEAL DIRECT WITH LABORATORIES

Increasing costs are sure to result in higher radio prices soon. Buy before the big advance—NOW!—while you can take advantage of Midwest's amazingly low prices. No middlemen's profit to pay. You save from 30% to 50% when you buy direct from Midwest Laboratories—you get 30 days FREE trial—as little as \$5 down puts a Midwest radio in your home. Satisfaction guaranteed or your money back.

**SAVE UP TO 50%**

Midwest Radio Corp., Est. 1930  
Dept. 525, Cincinnati, O., U.S.A.  
Cable Address: Miraco,  
All codes

**RUSH THIS COUPON FOR AMAZING 30-DAY FREE TRIAL OFFER AND NEW 1934 CATALOG**

**MIDWEST RADIO CORP.,**  
Dept. 525  
Cincinnati, Ohio.

Without obligation on my part send me your new FREE 1934 catalog, and complete details of your liberal 30-day FREE trial offer. This is NOT an order.

Name \_\_\_\_\_  
Address \_\_\_\_\_  
City \_\_\_\_\_ State \_\_\_\_\_

**AGENTS! Make Easy Extra Money**  
Check Here for Details

Spaced at intervals along the beacon path, are low-power marker beacons, directed upward, sending out their call letters and providing a check for the pilot as to his position along the beam. Thus radio enables the pilot to reach his destination unerringly.

### Landing "Blind" by Radio

Once over his destination, the pilot is confronted with breaking through the clouds—unless the clouds happen to lie right on the ground. Although such absolute zero-zero ("ceiling zero, visibility zero") conditions are comparatively rare, ceilings of less than 500 feet are not uncommon, and for all practical purposes are equivalent to zero. Things happen quickly at three miles a minute, and low ceilings have an unpleasant habit of becoming still lower without warning. Here once again radio comes to the rescue and provides an unerring means of bringing the airplane past all obstructions, to a three-point landing in the middle of the airport.

The problem of blind landing is solved by determining the position of the landing aircraft in three dimensions; lateral, vertical and longitudinal. The lateral guidance is provided by the runway localizing beacon, operating in the radio range beacon frequencies (200 to 400 kc.), and oriented to coincide with the landing direction. See Fig. 1.

A directional receiving antenna is used on the airplane, consisting of an addition to the usual vertical pole antenna of a flat-top element running back to the tail. Signals are received on the standard receiving unit used for radiophone and range beacon navigation, but instead of the vibrating reed instrument, a reed converter is used, which interprets the signals by actuating the vertical pointer of the combined instrument (course indicator). A reversing switch is provided for obtaining proper reading when flying away from or toward the beacon.

Vertical guidance is provided by a horizontally polarized ultra-short-wave directive beam set at a slight angle to the ground to provide the optimum gliding path for landing aircraft; the wavelength is 3.3 meters (90,800 kc.). The aircraft follows the path of constant field intensity below the inclined axis of the beam. A simple ultra-high-frequency receiver is used aboard the aircraft, fed by a transmission line from a horizontal half-wave receiving antenna located slightly ahead of the leading edge of the wing. The rectified output of this receiver actuates the horizontal pointer of the combined instrument, and indicates (in the vertical dimension) the position of the aircraft in relation to the gliding path. Both lateral and vertical guidance are thus shown on a single combined instrument, relieving the pilot of considerable mental effort in following the narrow gliding path.

### Longitudinal Guidance

Longitudinal guidance is provided by the reading of a direct current milliammeter connected in the plate supply to the radio frequency amplifying tubes of the beacon receiving set. Since the automatic volume control operates to increase the negative biasing voltage on the grids of these tubes, with increasing input voltages to the receiver, the plate current is approximately inversely proportional to the field intensity of the runway beacon; it is thus possible to calibrate the instrument in miles (usually 0 to 5). Absolute longitudinal information, when the aircraft approaches the field, is provided by two low-power radio-frequency oscillators (an audio-frequency oscillator providing grid modulation), utilizing antennas with radiation directed sharply upwards, and forming two vertical walls of sound through which the aircraft must pass. The first marker beacon warns the pilot that he is nearing the edge of the field, the second that the field boundary is passed. The reception is aural, and different modulation frequencies are used to facilitate marker identification. If the landing beam path is correctly followed, the height of the horizontal receiving antenna above the ground is 100 ft. and 50 ft. respectively at the two marker beacons. Knowing the distance between the antenna and the wheels of the airplane (about 15 ft. for a high-wing transport and 5 ft. for a low-

wing mail airplane), the pilot has all the necessary information to make a correct landing at the proper point within the airport.

The method of locating the runway localizing beam, at an airport situated close to a radio range beacon station, is illustrated in Fig. 2, which also shows how a pilot lost in the fog can pick up a radio range beacon, identify it, and follow it to the airport. Assume that the pilot is lost at the point marked "start." He hears letter "N," and knows that the beacon station is either north or south. He turns off the automatic volume control, sets his course either directly north or directly south (north, in this instance), and listens to the change in signal volume. The decrease in signal strength on the northern course tells him that the beacon station lies to the south. He turns around, and flies south until he reaches the beacon, where the "N" signal becomes a continuous note. To identify the beacon, he makes a 90° turn, either right or left, and listens for the signals to change. In this instance, let us suppose that he turns left, and shortly the signals change to letter "A." This definitely identifies the beacon, and tells him that the radio range beacon station lies somewhere to the south-west. He "rides the beacon" towards the station until he passes directly overhead, when all signals momentarily cease. (If the pilot is so completely lost that he does not know which range station is below, he only has to cruise on the beam until the next broadcast, when the station's call letters will supply him with this information.) Then, knowing the direction of the airport from the beacon station, and the distance, it is a simple matter to locate the radio landing beam and follow it clear to the ground. If the airport destination is located well away from a beacon station, the necessary information for the change of course can be supplied by suitable marker beacons, Fig. 3.

### Location of Sending Apparatus

A great advantage of this eminently practical system of radio navigation is its flexibility. The system can be adapted to meet any restrictions which an airport might possess, whether in location, obstructions, or possible sites for transmitting antennas. An interesting example of how the radio range beacon is used in place of a runway localizing beacon is illustrated in Fig. 3. The first marker beacon A, located 2 1/2 miles from the airport, warns the pilot to begin his glide preparatory to definite orientation. Knowing that at marker beacon B, two miles away, his altitude should be 300 ft, he gauges his glide accordingly, and once directly over the marker (when signals momentarily cease), he changes his course for the airport runway, in this instance, 22 degrees to the left. A blind landing beam would not be required here except for ceilings under 50 ft.

The once insoluble problem of blind landing has now been quite definitely solved by the use of radio, and much wider use of radio aids in aviation is distinctly indicated for the immediate future. Great as the progress in aviation has been, radio opens still greater vistas. There is a new and important field opening in the industry for the radio technician who is also familiar with flying.

The immediate prospect of wider use of radio blind landing systems waits upon the time when enough airports will be so equipped, to warrant wholesale installation of blind landing devices in all airplanes. Certain refinements and standardization, both in transmitting and receiving equipment, will undoubtedly be made, and the industry will resume its forward march as soon as the new Government policy on aviation becomes known. As we go to press, a special commission to determine this policy has been proposed, to submit its report by January 3rd, 1935.

The tide of progress cannot be stemmed. Aviation, our youngest and lushest industry, more than once accomplished the impossible. It is doing so today, and as long as the urge of conquest remains in the hearts of men, it will soar over obstacles in her path to new and greater heights. For the motto of the aviation industry is—PER ASPERA AD ASTRA!



## THE RADIO PEN

(Continued from page 13)

to a hotel in the heart of Manhattan on a frequency of 1,594 kc.) the pen moved across the paper 40 times for each inch of motion of the strip and the strip moved at a speed of about 2½ ins. per minute. If a slower speed were used, much greater detail could be obtained.

This speed is comparable with hand key transmitted telegraphy, or to telegraph printer speeds. It may be exceeded when the transmitted material is limited to text, and the engineers in charge of the development of the device expressed hope that much greater speeds will be attained as the device is perfected.

On the other hand, though, it was plainly stated at the demonstration that since the message speed in words-per-minute is less than half that which may be attained in speaking, and since it would require over three hours to transmit the text contained on a single newspaper page or more than a day to copy even a small newspaper, there is no reason to consider that the radio-pen in its present stage of development will supplant our daily papers.

There are many ways in which it can cooperate with the paper, though. For example, it might be used to supply "spot" news items which may be read at the breakfast table, to be read in full from the daily paper. Or even more likely, it will find application as an adjunct to sound transmissions (broadcasting). Children's programs could include pictures (which they might color) as illustrations of the stories, and news commentators could send pictures of the events they are covering, etc.

### Requirements of a Home "Radio Pen"

In conclusion, we are quoting a small part of the address given by the inventor, John V. L. Hogan, at the recent demonstration of the device, and in which he enumerated the features of his invention.

"These are the characteristics that it seems to me must be had in any recorded picture system which can be successful for home use:

"(1) The design must be sufficiently simple to permit the sale of the receivers at prices about the same as those of broadcast receivers.

"(2) The operation of the receivers must be so simple that they can be successfully handled by unskilled users, and the receivers must be capable of running for considerable periods of time with little or no attention.

"(3) The recorded pictures and text must be produced on plain paper, so as to avoid the nuisance, delay and expense involved in any chemical or photographic processing.

"(4) The operation of the receiving recorder must be fully visible, so that the user may see each mark as it is being made. This lends interest to the use of the system, but, more importantly, shows at once whether or not receiving conditions are correct.

"(5) The recorders must have a continuous paper feed, so that it is not necessary to reload the machine for each picture.

"(6) The received record should be made in ink, so as to provide a permanent, easily handled, non-smudging and dry copy.

"(7) The speed of the operation should be relatively high so that the user will not have to wait unduly long for each finished picture.

"(8) The reproduction should be sufficiently clear and crisp to permit the system to carry text at telegraphic speeds."

## AN ELECTRONIC TIMER

Many operations in manufacturing and professional work require a time delay between a mechanical motion and an electrical reaction. For example in X-ray timing, in certain types of spot welding an easily adjustable and accurately maintained time delay is essential. A well known manufacturer of electrical products has recently introduced an electronic time utilizing a grid-glow tube which provides a time delay continuously adjustable from 1/10-second to 45 seconds.

# FOR TODAY'S *and* TOMORROW'S PROFITS *your business demands . . .*



*very*  
the **Λ** best equipment!

Precision Multiwave  
Signal Generator  
Model 180

This new Supreme Precision Multiwave Signal Generator Model 180 will fulfill the requirements for an accurate Signal Generator for the new all-wave radios, which require extremely accurate tuning adjustments if double tuning effects and loss of sensitivity are to be avoided.

### QUICK FACTS ON MODEL 180

- Circuit.** The electron coupled circuit is employed offering excellent dynamic stability.
- Carrier-Frequency Range.** Carrier frequency of 90 kilocycles to 25 megacycles.
- Modulation.** Separate modulator stage that modulates the carrier frequency approximately 50% at 400 cycles.
- Frequency Calibration.** Each Signal Generator is individually calibrated at all frequencies with a guaranteed accuracy of ½ of 1%.
- Stability.** The calibration of the Signal Generator is independent of moderate variations of plate potential and external loads.
- Double Peaks.** No ml-loading double peaks, this is accomplished by proper design of inductors and amount of feedback.
- Tubes.** Two tubes, one type '32 tube utilized as an oscillator and one type '30 tube as a modulator.
- Power Supply.** Four batteries are required, two 4½ volt filament batteries and two 22½ volt "B" batteries.
- Power Consumption.** A total power consumption of 0.315 watts, insures long battery life.
- Stray Fields.** The Signal Generator and power supply are completely shielded, eliminating any possibility of stray radio frequency fields.

The price will amaze you, but the Precision Multiwave Signal Generator Model 180 is not a "price" instrument. Its beautiful scientific appearance is in keeping with its inherent operating merits and you can not obtain higher quality, greater accuracy, or better construction if you paid double the cost of this instrument. An instrument worthy of a place in the finest laboratory.

*Send the coupon today for complete details*

Initial orders will absorb present production schedule. The Supreme Precision Multiwave Signal Generator Model 180 is a custom-built piece of laboratory apparatus, and it is suggested that you place your order NOW for July 15th delivery.

Supreme Instruments Corporation,  
497 Supreme Bldg.,  
Greenwood, Miss.  
Gentlemen:  
Please send me, without obligation, full particulars on the Supreme PRECISION MULTIWAVE SIGNAL GENERATOR MODEL 180.  
Name .....  
Address .....  
City ..... State .....  
Jobber Preference .....

You can sell more  
Tubes  
with the  
**CONFIDENCE**

## Radio Tube Tester WHY?



1—One movement of Selector. 2—Read results on the original English Scale. Accurate! 3—Your customer can do it . . . and have confidence. 4—It is Fool Proof. Your customer can't hurt it. 5—Thousands in use all over the world. 6—Tests over 150 radio receiving tubes and other types. 7—Easy to keep up-to-date for possible future tubes. 8—Diodes, Triodes, screen grids, Pentodes and multi-element tubes. Both plates of all rectifiers. 9—Automatic plate short indication. And all other shorts. 10—Beauty of construction. Bakelite panel, gold finish. A tester you will be proud of. 11—Accurate line adjustment. 12—Confidence D'Arsonval Meter. 13—Portable and counter black leatherette cases. 14—A tester indicating faults in space charge, plate current, plate resistance and mutual conductance.

60 cycle, 103-130 volts

**\$34.50** F.O.B. FACTORY

Special frequencies and voltages extra

and now the

**CONFIDENCE**

WHEATSTONE  
BRIDGE

**\$19.85**

F.O.B.  
FACTORY



0.1 to 10,000,000 ohms. A genuine, simple, accurate Wheatstone Bridge. A new plan of making additional money is yours on request.

See Your Jobber or Write

**APPARATUS DESIGN CO.**

308 Rock Street  
Little Rock, Arkansas

SALES DEPARTMENTS

EARL WEBBER CO. C. W. BURTON  
Daily News Bldg. 755 Boylston St.  
CHICAGO BOSTON

Be sure to turn to page 58 of this issue and get full particulars about the OFFICIAL AUTO-RADIO SERVICE MANUAL, and the new FREE Supplements.

## Instantaneous Recording

The newest and greatest money making opportunity is now knocking at your door!

Increase your earnings by making recordings of Speeches, Radio Programs, Weddings, Orchestras, Singers, etc. We manufacture a complete line of Aluminum and Celluloid recording equipment for all needs.

Write for catalogue describing the Presto Universal Recorder—the recorder that is truly universal in its operation.

A sample of our newly developed "Presto Recording Disc" will be sent on request.

Make use of our free information bureau in solving your recording problems.

PRESTO RECORDING CORPORATION

"Everything for recording, from a needle to a complete studio installation."

139 West 19th Street  
New York City

## A RADIO CONTROLLED BOAT

(Continued from page 18)

in parallel, and operates on a minimum current of 1 ma.

This relay controls the selector switch which has 2 movable contacts or wipers which slide in an arc over 4 pairs of fixed contacts, due to the action of an electromagnet and ratchet. Starting at the zero or neutral position, one dot causes the wipers to move to the first pair of contacts, another to the second, and so on. By means of an air dashpot, a time delay is introduced so that if dots are sent in quick succession 12 dots per second, or faster) the wipers continue to advance, 1 step at a time. But if a pause of more than one-half second is made after any dot, the next dot will release the ratchet and the wipers will spring back to the zero position. In order to prevent actuating a device attached to any contact at which the wipers stop on the way to a higher position, and also to prevent sparking, all contacts are made electrically dead until the wipers have paused at least one-half second at a contact, whereupon a contact in series with the battery closes. This contact also opens just before the ratchet is released.

### The Selector Mechanism

The selector mechanism governs the operation of the motor which operates the rudder and sails. There is a worm gear on the shaft of the motor and whenever contacts 1 or 2 are closed at the selector, an electromagnet pulls a flat gear against this worm gear and the motor starts turning, causing the rudder to move slowly in one direction or the other, against a spring. In about 3 seconds the rudder is hard over (90 degrees) and a friction joint allows it to stay in this position until the release of one dot is sent, whereupon the rudder immediately springs back to a neutral position. The release signal can be sent while the rudder is at any angle from 0 to 90 degrees, consequently any desired amount of rudder deflection can be given to the ship.

Similarly, whenever contacts 3 or 4 are closed at the selector, another magnet pulls another flat gear into mesh with the same worm gear, causing a windlass to revolve, winding up or unwinding the 3 cords attached to the sails. When the motor is stopped by sending one dot as before, the gears disengage and the sails remain at whatever point they are left. Two contacts in the motor circuit are arranged so that the motor automatically stops when the sails are all the way in or all the way out, as shown in Fig. 1. Thus the sails can be adjusted to any desired angle and this angle can be quickly changed by any amount. About 5 seconds are required to let the sails all the way out from close-hauled.

In order to tell from shore exactly what is happening aboard the ship 2 flashlight bulbs are mounted on the mastsheads at important points in the electrical circuit, as shown in Fig. 1. One of these lights every time the sensitive relay closes, thus giving an indication of reception of the signals, and a means of re-tuning at the transmitter if necessary, while the ship is sailing. The other one, across the contact which is in series with the motor, lights while the wipers are advancing, and goes out as soon as the



Boat radio controlled 1/4 mile from shore.

motor starts. Hence it gives an exact indication of when the rudder starts to move, making timing more accurate.

### Additional Controls

The selector as actually built has two additional pairs of contacts, numbers 5 and 6, which are reached by the same number of dots and which have unlimited possibilities for further controls to be installed in the future. For example an auxiliary propeller has been designed to operate on contact 5, using the same motor by means of a clutch and belt drive, so that if the ship is becalmed, the auxiliary may be used to bring her to shore. Contact 6 might be used to sound a horn or siren, operate a camera on the deck, drop an anchor, drop two of the sails in case of an unexpected gale or in making a mooring, and so forth. The dial system of sending signals could be used if desired and would be advantageous if contacts 5 and 6 were used very frequently, or if more than 6 contacts were used. Dots could be sent as rapidly as 8 per second by this method and still be handled by the selector.

The arrangement of the various units inside the hull is shown in Fig. 2. The receiver, including the sensitive relay and the "C" batteries, is in the bow and can be readily removed through a 5 x 6 in. hatch simply by unscrewing 6 binding posts. Two portabsize "B" batteries and a home-made 6 V. storage battery occupy the central portion. The selector is mounted on 2 tube sockets so that it may be removed at any time for adjustment, the 12 electrical connections to the exterior circuit being made through the prongs of tube bases fastened to the selector. The motor is mounted in the stern with its shaft vertical, and is surrounded by the gearing system. The sheets run through small blocks on the deck and go below near the mizzenmast through an enclosed pulley block. The masts are removable for convenience in transportation. The hull is 4 ft. long (5 ft. overall), the height from waterline to tip of mainmast is 6 ft., and the draft is 13 ins.

The boat has been successfully operated without careful adjustment up to about one-quarter mile, which is the limit of sailing visibility, and with careful adjustment of sensitivity and by using field glasses it should be possible to cover a one-half mile radius, for the receiver has been tested successfully over this distance on land. With more power at the transmitting end, much greater distances could be covered. The yacht handled with surprising ease considering her "tubby" lines, and excessive weight. She could tack to within about 20 or 30 degrees of the wind, run before the wind, come about quickly, and be sent over almost any predetermined course.

## A PRACTICAL LINE FILTER FOR ALL-WAVE SETS

(Continued from page 28)

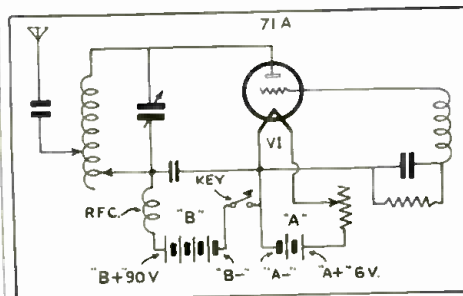

Transmitter for controlling boat.

lem through the back door, so to speak, by designing a line filter that would really be effective on the higher frequencies.

The result of many weeks of experiment in several different locations is shown in Fig. 1. Literally hundreds of different combinations of inductances, condensers, and resistances were tried in an effort to produce



a filter that would absolutely eliminate every trace of line noise in the all-wave receiver between 11 and 550 meters.

Needless to say the values given in the List of Parts are those which were found to be superior to all others in producing the desired results, and any deviation, except where noted, is not recommended. All types of inductances from the old "spider-web" to bank-wound solenoids were tried, but the duolateral or "honeycomb" coil with its low distributed capacity was found to be most effective. Incidentally, as the inductances must be able to carry the entire current drawn by the receiver, a heavy gauge wire must be used in this filter. The condensers should be of the mica type, moulded in bakelite, as they are non-inductive, have low leakage, and are impervious to atmospheric conditions. The value of the four fixed condensers used is .0055-mf. each. Other sizes may be substituted but the filter will not be as effective. The variable filter tuning condenser is a compensator type with a maximum capacity of 100 mmf.

#### Coil Construction

Five 100 turn coils are needed. Four are used as they are, but the fifth one L.T. is adjusted by the "cut and try" method until the tuned circuit L.T. and C.T. is peaked at the most efficient point. The coils are mounted on a bakelite, hard rubber, or wooden panel approximately 3½ x 7 ins., as shown, using a small piece of bakelite ½ x 3 ins. to hold L1-L2 and L3-L4 in place. A larger piece, used to mount L.T. and C.T., is fastened on top of it. Screws, running through these small pieces and the panel, clamp the coils in place. The fixed condensers are mounted on the panel with screws in the positions shown. The ground leads of the condensers are wired to the ground binding post which is mounted on the cover of the shield can.

The remaining equipment needed is a power cord with plug, an outlet receptacle, and a metal shield "can" approximately 4½ x 8 x 6 ins. high. This may be a cracker tin, or a sheet steel or aluminum box.

#### Installation

After the filter has been assembled and wired exactly as shown in the diagram, it is ready to be installed and adjusted. It should be located as near the receiver as possible and the power cord between the filter and set should be shortened. The method of connection is clearly shown in the illustrations and needs no explanation. A good ground from a water pipe is connected to the ground post on the filter. Both power plugs should be reversed individually until the best combination is found.

To tune the filter we turn the volume control of the receiver up full and tune the background noise is at its highest. Now vary C.T. from maximum to minimum, listening for a decrease in the noise. If none is noted remove approximately ten turns at a time from L.T., varying C.T. as above until the point of minimum noise is found. The final size of L.T. may be as small as ten turns as its size is determined by the frequency of maximum interference.

As a final touch, the connections to the large coils may be reversed one at a time until the whole filter is functioning at peak efficiency.

The total cost of this unit was under 3 dollars and in the writer's estimation it is an investment paying big dividends in increased pleasure in operating the all-wave receiver.

The construction is extremely simple as there are but few parts. Although the adjustments are not overly critical, reasonable care must be exercised to achieve the desired results.

#### List of Parts

Four Polymet .0055-mf. fixed mica condensers, C1, C2, C3, C4;  
One L. C. A. or Hammarlund 100 mmf. trimmer condenser, C.T.;  
Five Harrison 100 turn honeycomb coils, L1, L2, L3, L4, L.T.;  
One shield can;  
One bakelite sub-panel;  
One power cord and plug;  
One A. C. outlet;  
Miscellaneous hardware.

## ITS USE REFLECTS ITS CHARACTER

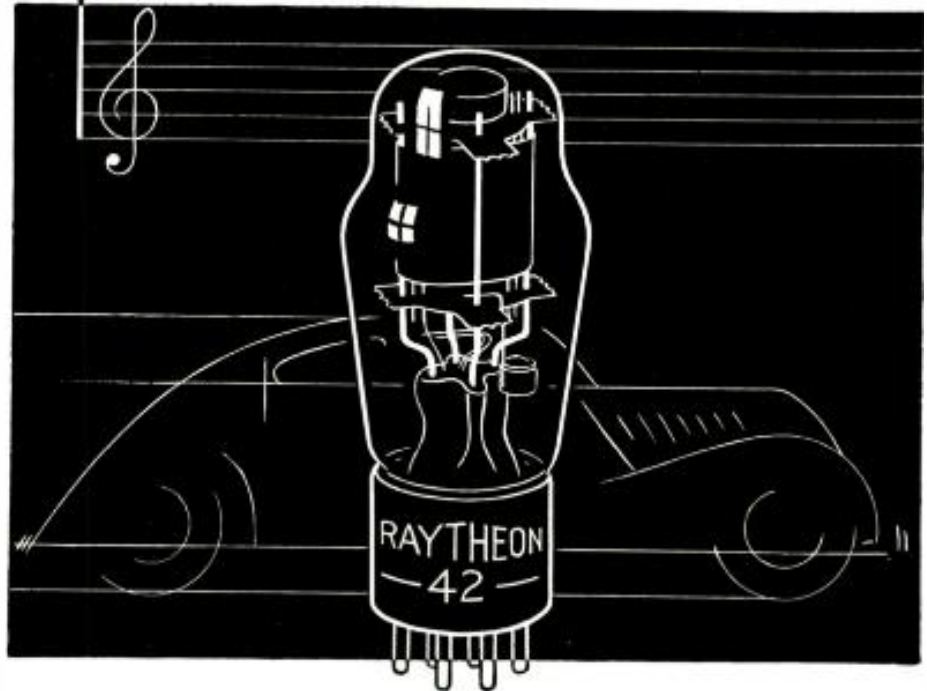

LIKE a human being, the character of a radio tube can be told by the company it keeps. If there is an integrity of purpose behind it, a superb skill in its manufacture, these will be reflected in its use in places where only the finest of precision instruments can be used.

Huge planes of the great continental transport companies, alert police cars on watch throughout the country, expeditions probing the farthest reaches of the earth, buy and use Raytheon 4-pillar Tubes because of their precision-construction, and because of the 4-pillar-support principle which guards this precision.

The automobile radio, now vastly increasing in use, demands a radio tube that can withstand the cruelest treatment. And it is not to be wondered at if automobile manufacturers, installing these radios as standard equipment in their cars, specify Raytheon 4-pillar Tubes.

When you use Raytheon 4-pillar Tubes in a set you are assured of satisfactory performance. For Raytheons are built with an integrity and a soundness that recommend them to all who look upon the tube as the very heart of the set. The advantages of their particular construction are attested by their use wherever rigorous conditions are encountered.



# RAYTHEON

## 4-PILLAR RADIO TUBES

RAYTHEON PRODUCTION CORPORATION

30 E. 42nd St.  
New York City

55 Chapel St.  
Newton, Mass.

415 Lake Shore Drive  
Chicago

555 Howard St.  
San Francisco





popularly called the police coil because it covers the police radio alarm stations. The owner of this receiver will never have a dull moment!

#### List of Parts

One Trutest set of three-winding plug-in coils, 14-200 meters, L1;  
 One Trutest 8 mh. R.F. choke coil, RFC;  
 One 140 mmf. variable condenser, C1;  
 One 20 mmf. variable condenser, C2;  
 One 100 mmf. grid condenser, C3;  
 One 250 mmf. condenser, C4;  
 Three Trutest .1-mf. condensers, C5, C6, C7;  
 Two Trutest 0.5-mf. condensers, C8, C9;  
 Two Trutest condensers, .25-mf., C10, C13;  
 One Trutest 10 mf. condenser, C11;  
 One .001-mf. condenser, C12;  
 One Trutest .5-mf. condenser, C14;  
 Two Trutest .1-meg. resistors, R1, R7;  
 One Trutest 300 ohm resistor, R2;  
 One Trutest 75,000 resistor, R3;  
 One Trutest 5 meg. grid leak, R4;  
 One Centralab 50,000 ohm potentiometer, R5;  
 Two Trutest 50,000 ohm resistor, R6, R8;  
 One Trutest .5-meg. resistor, R9;  
 One Trutest 500 ohm resistor, R10;  
 One 110 V. line switch, Sw;  
 One Trutest output transformer, T1;  
 One Lafayette type 58 tube, V1;  
 One Lafayette type 57 tube, V2;  
 One Lafayette type 2A5 tube, V3;  
 One welded steel chassis, black crystalline finish;  
 Four Eby 6 prong sockets for the tubes and the plug-in-coils;  
 One vernier dial for the tuning condenser;  
 One double binding post strip;  
 Two tip jack strips;  
 One 8 wire cable and 6 prong plug;  
 Necessary hardware, wire and solder for connections, etc.

#### List of Parts for the Power Pack

One Trutest power transformer, T2;  
 One Trutest filter choke, T3, T4;  
 One Trutest three-section electrolytic filter  
 One type 80 tube, V4;  
 One welded steel chassis, black crystalline finish;  
 One 4 prong socket for V4;  
 One 6 prong socket for connector plug;  
 Necessary hardware, wire, etc.

## RADIO DEVICE GUIDES THE BLIND

(Continued from page 12)

the direction of the beams. The angle of these sanded strips indicates the direction of turn. Two strips indicate a doorway, while three denote a stairway.

As a blind person's sense of touch is very highly developed, these friction strips are never missed.

By using mirrors, the inventor found that he could bend, or change the direction of the light beams and he has been able to throw beams with a working range of 125 feet from each light source. As a matter of fact, the length of the beam is determined solely by the strength of the light source, and the sensitivity of the optical system.

As an added precaution on stairways, supplementary beams, wholly independent of the main beam system are used. These units, one of which is shown in Fig. A, at the right, are self-contained and operate without the aid of the pick-up devices carried by the blind persons. These units consist of a cabinet with two small turrets on either side, behind one of which is a source of light, and behind the other a photoelectric cell. A person walking down the stairs in the path of these rays casts a shadow, which in turn causes a buzzer to sound on top of the cabinet, as long as the person is in the path of the rays.

These simple light rays, in conjunction with a photoelectric device, point the way for much more useful and complete set-ups for the guidance of blind persons. There is no reason why every home in which a blind person lives can not be equipped with some form of this system either more or less complicated as the case requires.



**—INCLUDING  
SOCKET SELECTOR SET,  
LEADS, CARRYING CASE,  
ETC.**

# THE *New* WESTON

Model 698

## SELECTIVE SET SERVICER

Here is the new, compact and complete Weston Selective Set Servicer — the last word in field analysis equipment for the aggressive service man.

It is Weston designed, and Weston built throughout — yet offered at a price within reach of all. It employs the new Weston principle of Selective Analysis, which eliminates all danger of early obsolescence. And it is offered *complete* at this low price; including Model 697 Volt-Ohm-Milliammeter, the new Model 666 Type IA improved Socket Selector Set, all leads, instructions, carrying case, etc. There is nothing more to buy. As for dependability and accuracy, the name it bears assures you of that.

You will want complete data on this dependable Weston field servicer. See it at your jobber's today. The coupon will bring all the facts . . . Weston Electrical Instrument Corp., 599 Frelinghuysen Ave., Newark, N. J.



# WESTON

 *Radio Instruments*



WESTON ELECTRICAL INSTRUMENT CORPORATION  
599 Frelinghuysen Avenue, Newark, New Jersey  
Send Bulletin on Weston Radio Instruments.

Name \_\_\_\_\_  
Address \_\_\_\_\_

# PUBLIC ADDRESS!

From the Microphone  
to the Horn



TYPE "BF"  
MICROPHONE

2 - button,  
heavy duty,  
chromium  
plated, size:  
3 1/4" x 2 1/4".  
Freq. Resp.  
50 to 4,000 cycles.

(One of five available type  
microphones which includes  
the velocity type.

Net Price  
**\$4.95**

## SHORT WIDE ANGLE No. 710 HORN

Constructed of  
non-resonant  
material braced  
with steel. Completely  
waterproof. Overall  
length 22", bell  
22" x 23".

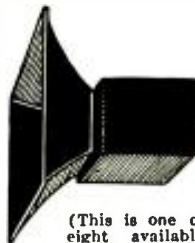

(This is one of  
eight available  
types of horns).

Net  
Price **\$5.40**

### WE ALSO MANUFACTURE:

- 9 Models of Microphone Stands.
  - 24 Models of Permanent Power Amplifiers.
  - 23 Models of Portable Power Amplifiers.
  - 6 Models of Dynamic Field Exciters
- AND ALL SPECIAL EQUIPMENT  
FOR THE PUBLIC ADDRESS  
FIELD.

Microphones and All P.A.  
Apparatus Repaired.

Send 3c Stamp for Catalogue

## RADIO AND AMPLIFIER LABORATORIES

291 East 137th St., New York City

## When Seeking a Radio School . . .

Consider the advantages of RCA  
Institutes

Whether elementary radio principles or advanced subjects, sound applications or practical radio engineering, RCA Institutes is prepared to give you the instruction you need.

Students attending our Chicago School this Summer have added advantage of combining a study of the scientific wonders of the World's Fair.

RESIDENT SCHOOLS NEW YORK & CHICAGO  
with modern standard equipment

EXTENSION COURSES FOR HOME STUDY  
under convenient "no obligation" plan

Illustrated Catalog on Request.

R.C.A. INSTITUTES, Inc. Dept. RT-34  
75 Varick St., New York—1154 Merchandise Mart, Chicago

## LATEST RADIO EQUIPMENT

(Continued from page 11)

cy. Designed to operate with any sound head and to match output impedances of 8, 16 and 500 ohms.

### NEW DEAF SET (No. 481)

A COMPLETE kit for the hard-of-hearing. Incorporates a headphone and earphone. The latter is supplied with removable hard-rubber earpieces for either orifice. The battery case uses standard removable cells. The microphone is designed for moderate sensitivity and incorporates a volume control.

### DRY DISC DETECTORS (No. 482)

ALTHOUGH it is preferable to use dry-disc rectifiers especially designed for either R.F. or I.F. operation the unit illustrated may be used for both services. In the former operation it is perhaps best compared to detectors of the carbundum type; in the latter, to a regular diode; in both positions square-law (straight line) rectification is obtained—thus, this unit is useful for high-quality detection and in A.V.C. circuits.

### "MIDGET" ELECTROLYTIC CONDENSERS (No. 483)

IMPROVEMENTS in the manufacture of dry electrolytic condensers have made it possible to produce the units illustrated which, comparatively, are only about one-half the size of previous types having the same ratings. Items A, B and C are 4 mf. units rated at 500 V. Standard capacities in ratings of 220 V. and 525 V. are available.

### GASOLINE-DRIVEN ELECTRIC PLANTS (No. 484)

ALTHOUGH the gasoline-driven electric generating plant illustrated has an output rating of 2,000 W. other models are available to meet requirements of 300 to 35,000 W. A fine proposition for the progressive radio Service Man covering isolated territories. Both air and water cooled types are available, depending upon the rating, for obtaining A.C. or D.C. as required. Available in manual, self-starting and full automatic types. All 3 models may be started and stopped by remote control; the automatic type will supply current automatically as required. (For instance, where refrigerators are installed and intermittently require current).

### DETECTIVES' LISTENING-IN EQUIPMENT (No. 485)

THIS apparatus was designed by a police officer. It is possible for a detective and a stenographer to listen and simultaneously monitor a conversation. Equipment includes 6 ultra-sensitive microphones, 2 pairs of headphones and a 2 stage amplifier incorporating a volume control, and a high- and low-sensitivity switch. Radio organizations servicing police radio equipment will find this a profitable item.

### A SELECTIVE SET-SERVICER (No. 486)

THE "selective set-servicer" instrument illustrated is used in conjunction with the "socket selector set." This combination furnishes extreme flexibility in test equipment for



radio set analyses. Designed to be adaptable to expansions in demands. Complete equipment for field servicing of faulty radio equipment includes a volt-ohm-milliammeter, a socket selector-set, leads, and leatherette carrying case. Designed to overcome the tendency toward rapid obsolescence that has cursed most previous test unit designs—a fact to which too many depleted pocketbooks attest.

### MIDGET REPLACEMENT ELECTROLYTIC CONDENSERS (No. 487)

EXACT duplicates of electrolytic condensers used in A.C.-D.C. commercial midget receivers are now available. Many of these types, in all respects similar to the units they replace, are illustrated.

Note that, where space permits, the peak voltage rating of each condenser section has been raised to insure a product superior to the original.

### DUAL-WAVE RADIO-PHONO. COMBINATION (No. 488)

THE superheterodyne illustrated will receive either the broadcast band or frequencies in the range of 1,500 to 3,500 kc. (200 to 83.4 meters, approx.). A 2 position tone control is provided. The 78 r.p.m. turntable will "play" 12-in. records. The cover of the cabinet has slip hinges. One, each, of the following types of tubes are used: 6A7, 6F7, 41 and 1V.

### IMPROVED DISC RECORDER (No. 489)

A 2 CASE "universal" recorder is illustrated. This instrument incorporates in one case the A.F. amplifier and its controls, calibrated volume indicator and dynamic reproducer. The A.F. amplifier gain is 92 db.; its power output, 10 W. It uses the following tubes: two 57s, 56s, and 83s, and one 5Z3. The power unit supplies the microphone and (if desired) radio tuner current.

The other case contains the turntable and its motor. The latter is a constant-speed A.C. type which drives the turntable at its periphery; and, at either 33 1/3 or 78 r.p.m. Two feed screws and cutting-head mechanisms are supplied. Head A cuts non-metallic discs; head B, metallic. The amplifier case is 6 x 16 x 9 ins. high and weighs 51 lbs. The turntable case is 16 x 16 x 11 ins. high; weight, 42 lbs.

### A LADDER-TYPE ATTENUATOR (No. 490)

AN ALUMINUM shield encloses the illustrated, high-quality unit. Its frequency characteristic is flat from 20 to 20,000 cy. Attenuation is accomplished in 53 steps of 3/4-db. each. Standard impedances of 50, 200 or 500 ohms; special values to order. The unit measures 2 5/16 x 2 3/8 ins. in dia.

### AIRCRAFT RADIO BEACON RECEIVER (No. 491)

FOR aircraft reception in the beacon range of 200 to 410 kc. (1,428 to 731.3 meters) there has been designed the instrument illustrated. The 6 tube superheterodyne chassis incorporates 3 type 30 or 44 tubes, 1 37, 2 85s and 1 89; the power output is 1.5 F. Either 6 V. or 12 V. type available. Remote volume and crank-type tuning are provided. The "B" supply is of dynamotor type. Its drain is 1.8A; tube filaments, 1A. Twin phone jacks are provided.



Above—Two lead-coated terminals for connecting auto-radio set directly to car battery (No. 493).

Left—A kit of tools for the Service Man including socket wrenches, test leads and test prods with various types of tips and connector points. The use of individual socket wrenches is a quicker servicing procedure than using one handle with a number of removable heads. (No. 494).



# Service Engineers' 1934-B REPLACEMENT TRANSFORMER

# Catalog!

8 pages 8½" x 11"—fits your price manual or ready reference file.

Lists power transformers shown for any set from 4 tube midsets to 12 tube super-power, 110-120 V., 220-240 V., 50-60 cycle—or 115 V., 25-40 cycle.

**Gives Complete Information Regarding:**

*"Multi-Tap"* Universal Transformers

5 units for any of 1997 models of radios—from smallest to largest high-powered sets.

Exact duplicates for 500 models of the most popular sets.

Auto-Radio Multi-Tap "B" power and single and synchronous vibrators.

Class B amplifier and Amateur broadcasting equipment.

Also—Outputs, Input Audios, Interstage coupling chokes for every need.

Tube tester, microphone, Step-down and Step-up transformers.

# Free for the Asking!

The most comprehensive manufacturers' catalog of power supply units for replacements or for new set building, will please you. Illustrations—units listed, giving code word, dimensions, technical description, shipping weight, and list price of each.

**MAIL THIS COUPON TODAY!**

GENERAL TRANSFORMER CORP.,  
504 South Throop St., Chicago, Ill.  
Please send me, without obligation, your 1934-B Catalog and address of nearest distributor.

Name .....

Address .....

City..... State.....

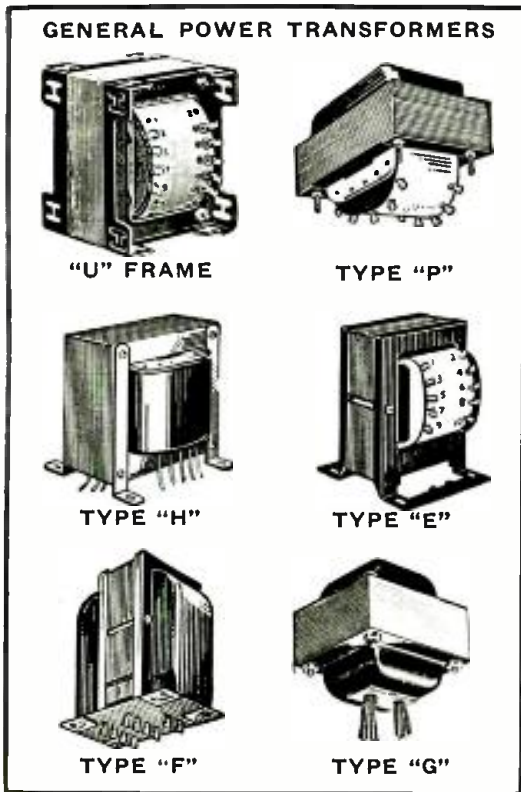

**GENERAL TRANSFORMER CORPORATION**  
504 South Throop St. Chicago, Illinois

## AUTOMOTIVE RADIO ANTENNAS (No. 492)

A, B, and C are shown antenna types to suit individual requirements; a car-antenna specialist manufactures these antennas. At A is shown the popular running board type. At either end are pressed-steel brackets. Two sizes are available, one having 500 ft. of wire and the other 1000 ft. This is a rigid antenna. At B is shown a tubular type for use under car. At C is shown, flat-coiled to a dimension of 9 x 36 x ¼-in. thick, an auto-top type of antenna which, when uncoiled and spread out on the top, has an area of 3 x 5 ft.

## A BATTERY CONNECTOR (No. 493)

CONNECTING auto-radio set leads directly to the lighting system of the car, including the instrument board ammeter, results

in an undue increase in ignition interference pickup. Therefore, Service Men will welcome the lead-coated brass connector shown, which permits direct connection to the storage battery.

## SERVICE MEN'S KIT (No. 494)

SERVICE MEN will find the kit shown at 494 on the preceding page an almost indispensable part of their service equipment. The complete layout of tools shown, includes long prod handles, short prod handles, insulated tapered-type lugs, needle point phone tips, alligator clips, insulated plug-in prongs and prong jacks, 5 ft. test wires, straight socket wrenches of various sizes and two elbow socket wrenches, as well as a screw holding screw driver.

The complete layout of tools shown is being given to dealers and Service Men as part of a merchandizing plan.

## TEST SIGNAL GENERATOR (No. 495)

A TEST oscillator covering the intermediate frequencies and the regular broadcast band (from 100 to 1,500 kc.) which supplies high-priced performance at a reasonable cost appears at No. 495. It is electron coupled, using a 6F7 and a 37 tube, uses a separate modulator circuit, operates from either the A.C. or D.C. lines, is completely shielded and the parts are individually shielded, has a direct-reading dial and has a scientifically designed attenuator for adjusting the output of the oscillator for sets of extreme sensitivity and those with poor sensitivity.

The frequency is stable and the output constant which is extremely useful in testing, aligning and comparing the efficiencies of different sets. The unit is enclosed in a leatherette case 10 x 7½ x 5 ins. deep.



An electron coupled test oscillator with unusual features permitting tests which have heretofore been possible only with high priced instruments. The signal frequency range is 100 to 1,500 kc. The A.F. modulation is 400 cycles. (No. 495)

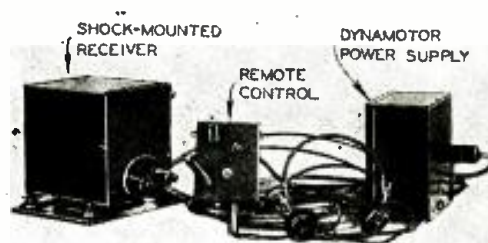

Above—An aircraft beacon type radio receiver which tunes to frequencies between 200 and 410 kc. (No. 491)

Right—Three types of automotive aerials. At A, is a running board type, at B, is a tubular type for use under the car, under the running board or with the bumpers and at C is the flat coiled type for the car roof. (No. 492)

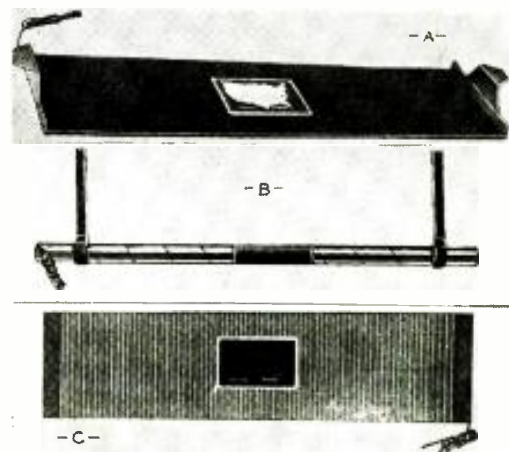



Nothin' wrong with this boy... If you ask us he's a tough hombre . . . he ought to be . . . for he was Baptized with Fire at 2700 degrees and he's vibration proof, heat proof and moisture proof.

On that next replacement job try a CENTRALAB FIXED RESISTOR and note the difference. Good business too . . . for the customer won't be coming back with a squawk.

Every Radio Service Man should be a member of the Institute of Radio Service Men

At your jobber.

**Centralab**  
CENTRAL RADIO LABORATORIES  
MILWAUKEE WISCONSIN

# AUTO-RADIO

## B-Power Supply Parts

### Universal Vibrator Rectifiers

Cat. No.	Description	Net. Price
400	Full Wave Vibrator with leads	\$2.10
450	Full Wave Vibrator 4 prong plug 2 1/2" dia.	2.30
451	Full Wave Vibrator 6 prong plug 2 1/2" dia.	2.30
452	Full Wave Vibrator 6 prong plug 1 1/2" dia.	2.30
3030	Synchronous Vibrator with leads	3.00
3031	Synchronous Vibrator Plug in type	3.00

Our 400 non-adjustable vibrator will replace 60% of all vibrators used (Oak vibrator included.)

### Auto Radio Power Transformers

413	For 135 Volts 40 Ma.	1.80
412	For 180 Volts 40 Ma.	1.95
411	For 250 Volts 50 Ma.	2.10

### Exact Duplicate Power Transformers For

414	Oak Mfg.	3.60
415	Carter Single Vibrator	2.40
416	Carter Double Vibrator	2.40
417	Radlart Single Vibrator	2.40
418	Mallory half wave Vibrator	3.00
419	Stewart Warner 11T-112	3.60

All other makes rewound to exact duplicates... 3.00  
Multi-tap B-Power Supply Units complete with taps for 90-135-180-250 volts with tube rectifier or synchronous units... \$9.00

SATISFACTION GUARANTEED

**PEMBLETON LABORATORIES**

Dept. J-921

921 Parkview Ave. FORT WAYNE, IND.  
(We Do Not Repair Radios)

## ALL-WAVE ANTENNA SYSTEMS

(Continued from page 21)

line noise eliminator should be installed between the all-wave set and its wall-receptacle connection to the power line, before anything further is done toward improving the signal-to-noise ratio.

Whether the antenna lead-in should be unshielded, shielded, or transposed is a matter dependent upon 2 factors: (1) the type of antenna system, and; (2) the amount of man-made local interference. In general, an unshielded lead-in is most to be desired, provided the location is free from all sources of electrical "noise." A more detailed discussion of these 3 types of lead-ins is found in the following comments relating to antenna systems 1 to 7, and the corresponding figures.

### An Ultra-Modern All-Wave

#### "Double Doublet" Antenna System

(1) Double Doublet. In Fig. 1 is illustrated the product of some of radio's highest calibre engineers—the most efficient and practicable all-wave antenna system so far developed. Its component parts, with which the up-to-date Service Man must equip himself, are illustrated in Fig. A, and comprise the following units: 1 all-wave impedance-matching coupling coil or transformer, equipped with a 2 position switch; 1 100 ft. length of all-wave R.F. transmission line transposition-cable; 2 lengths, each 46 1/2 ft. long, stranded doublet wire; 1 crossover insulator; 4 (3 shown in photo.) strain insulators; 1 lead-in porcelain tube; 2 nailing knobs; 1 ground clamp; 2 pieces of cambrie tubing.

There are installed between the two supporting poles two distinct doublets—one doublet having 29 ft. for each half-section, and the other 16 1/2 ft. for each half-section. The purpose of this "duo-dipole" arrangement is to approach an ideal antenna system for all the short-wave and broadcast bands. Theoretically it would be best to have a doublet designed and installed for each one of the 5 bands assigned by International agreement for practically all foreign short-wave broadcasting namely, one each for the 16, 19, 25, 31 and 49 meter bands. This would mean 5 doublets, each one of which would require to be sufficiently separated from its neighbor to prevent disturbance of the reception. Obviously this would be quite an installation problem and economically prohibitive. However, the arrangement shown in Fig. 1 has been found to be a practical approach to the ideal, as the 29 ft. sections tend to tune or match the system toward the low-frequency end of the short-wave broadcast band, namely, toward 49 meters, and the 16 1/2 ft. sections tend to tune or match the system toward the high-frequency end of the short-wave broadcast band, namely toward 16 meters. The connection of both doublets, or the "double doublet," to the transmission line, tends to give a smooth match throughout the short-wave broadcast band. Note that the resonance peaks which occur at harmonics of the larger doublet's fundamental frequency tend to boost response to some of the shorter-wave bands; however, it is impossible for the smaller doublet to increase response on this principle inasmuch as there cannot be "harmonics" at frequencies lower than the fundamental.

Determine the correct lengths for each doublet (which is made from the two continuous antenna wires, each of which is 46 1/2 ft. long; 6 ins. are allowed for each antenna strain insulator tier, by reference to a thinned spot which will be found on the wire. Connect the transmission line to this spot by soldering as per detail A in Fig. 1. Note that the long and short antenna wires, which are connected together, are located on opposite sides of the center transmission line connection.

Height above ground should be considered as the distance from the 29 ft. horizontal sections to ground, the latter to be considered as earth ground if the span is on top of a frame dwelling with no grounded metal roof, or from a building to a nearby pole, tree, or another building. If the span is installed on top of a steel framework building, or any building with a grounded roof, the

earth ground is usually considered to be at the roof. For good results a minimum of 30 ft. above ground is recommended. Remember that the signal strength received varies with the height above ground).

Theoretically, the horizontal doublet should be stretched out fully—each half making an angle of 180 deg. with the other, as shown in Fig. 1—for most efficient reception. If this angle is reduced, due to constructional difficulties to, say, 90 deg., signal strength will be decreased about 30% as compared to the signal received from the horizontal doublet in its full 180 deg. span.

The total length of the special "all-wave," twin-conductor transposition-cable (which is not merely "twisted pair") must always be used regardless of whether the doublet antenna system only requires, for example, 60 ft. of line to be run in order to reach the receiver. Coil up the balance of 50 ft. in a convenient diameter, such as 1 ft., at the receiver end. For distances greater than 110 ft., additional full lengths of line must be added in multiples up to 2 times, or up to 220 ft. After this distance, although additional 110 ft. lengths can be added for runs up to 500 ft. these lengths may be cut anywhere convenient for connection to the receiver, as shown in Table II

Table II

Run (Feet)	TRANSPOSITION-CABLE LEAD-IN DATA	
	Length of Cable Use (Feet)	Coiled (Feet)
95	110	1
150	220	2
210	220	2
300	300	3
500	500	5

(\*Coil unnecessary. Unused portion may be cut off.)

### Lead-in Impedance Matching at All Wavelengths

Due to a most efficient match of the new double doublet to the all-wave receiver for the higher frequencies (lower wavelengths) of 3.5 to 20 megacycles, there would be an unavoidable loss introduced for the frequencies assigned to "standard" broadcasting, police calls, etc., namely, 500 to 3,500 kc. A switch is therefore provided on the all-wave coupling transformer for improving the reception of the stations operating on the frequencies between 500 and 3,500 kc. Strong local stations can, of course, in most cases, still be received with the switch in the short-wave receiving position.

This all-wave coupler is specially designed and serves 4 functions: (1) It couples the low-impedance R.F. transmission line to the receiver; (2) by its design, and use of electrostatic shielding, it balances out the capacity of the transmission line to ground; (3) it balances out local interference picked up by this transposition-cable lead-in (that is, R.F. transmission line), and; (4) it permits a ground connection to be used on the radio receiver, thus reducing any tendency toward producing hum or circuit instability.

The all-wave coupler or impedance-matching transformer is designed to mount directly on the antenna-ground terminal board of RCA Victor all-wave receivers, such as models 140 (late production only), 240, 120, 121, 320, and 321, thereby insuring the shortest possible connection to the antenna and ground terminals. (The installation of the transformer to a late-production RCA Victor model 140 is illustrated in Fig. 1.)

It is important to note that the length of the ground connection of this coupler is critical. Therefore, to insure maximum noise reduction keep this connection at the shortest possible distance (not over 1 in.) from the chassis ground. On early-production models of the RCA Victor 140, terminal No. 1 (grounded to chassis) of the phonograph terminal board, located at the rear of the chassis, should be used in getting this important short ground connection for this model. By utilizing this terminal easy mounting of the transformer is obtained. Care should be exercised to prevent the transformer antenna terminal from shorting to the chassis.

On other manufacturers' receivers, having the chassis grounded, the transformer should be mounted on the side of the cabinet (by utilizing holes, spacers and screws provided in such a manner as to permit having the



# Most Popular Public Address Horn

*Clear and Distinct on Voice—Beautiful on Music*

Its patented solid leather spider protects the air gap against water, dirt and grit. The different input impedances make any number of these units adaptable to most any amplifier.

## Wright-DeCoster P. A. 20

Weighing only 41 lbs., it can be easily handled and hung in position by attaching wire to the two eyelets on the horn and the handle on the unit housing.

The unit housing is detachable from the horn and can be easily removed without the use of any tools. In this manner, it can be used for indoor installations and will give ample coverage for any small hall or auditorium. The Horns may be nested for easy transportation when units are removed.

Sensitive enough to operate on one watt. Powerful enough to handle nine watts. Furnished with separate field supply mounted in metal cabinet which will take care of from 1 to 3 of these reproducers perfectly.

Never has a more flexible, adaptable and money-making combination been offered to the sound engineer. Write for full particulars and prices.

**WRIGHT-DeCOSTER, Inc.,** 2251 University Ave.,  
ST. PAUL, MINN.

Export Dept. M. Simons & Son Co., 25 Warren St., New York  
Cable Address: SIMONTRICE, New York



Knocked Down



Assembled

Notice: If you are using Wright-DeCoster Products and are not receiving our monthly sound letters, write us to add your name to our list. This monthly information will be helpful to you in your business.

Also see Page 42

transformer ground connector, when bent, to slip under the ground terminal or a chassis nut. If this is not possible make the ground connection *absolutely as short as possible*.

The length of the antenna connection to the all-wave coupler is not as critical as the ground lead, insofar as noise reduction is concerned. However, this connection should be kept as short as convenient and close to the chassis, and away from the control-grid leads of the receiver's radio tubes. For the ground lead, use No. 14 rubber-covered wire or larger, if possible, and keep the run as short as possible.

### De-Tuning Effect

On the RCA Victor model 140 all-wave receiver it will be found that connection of the lead-in coupling coil will tend to throw the antenna circuit for band "D" out of alignment. This should be checked in the usual manner by use of the tuning wand (The use of this tool was described and illustrated in RADIO-CRAFT, January 1933, pg. 415; the illustration is Fig. 1.), realigned with the range switch at "D," and the station selector turned to the 25 meter band. If there is no broadcast station or service oscillator signal available, use background noise as a basis of line-up.

It will be noted that on most converter-type short-wave receivers (such as RCA Victor Universal Radiola model R6-23) the use of this all-wave antenna kit, with its all-wave coupler, reduces serious cross-modulation effects from nearby commercial code, airport or amateur code station. This is an obvious advantage and owners of these types of receivers will welcome the installation of this kit.

(Part II, to follow, describes 6 other types of all-wave antenna systems, together with their respective advantages and disadvantages, concluding with graphic illustration and a more detailed discussion of certain important factors in DX or long-distance reception of radio station programs on wavelengths in the "all-wave" range of 15 to 550 meters.)

## INFORMATION BUREAU

(Continued from page 33)

an aerial coupler and should preferably have a large primary, universal-wound and loosely coupled to the secondary. The second coil is an interstage coil designed with a high-impedance primary for use in the plate circuit of an R.F. pentode tube. The resistance values of the coils used in the General Electric set are shown in parentheses on the circuit.

The volume control consists of a 0.2-meg. variable resistor with a small limiting resistor of 300 ohms at the minimum end. To insure protection to the tubes, and long life for the batteries, a double-pole single-throw switch is used to turn the set on and off. This switch breaks both the filament and the plate circuits. Trimmer condensers are shunted across both sections of the 2 section tuning condenser, so that perfect alignment can be attained.

The speaker shown is a magnetic unit, although somewhat better quality could be obtained by the use of a dynamic unit having a 6 V. field coil. However the "A" battery would require more frequent charging with this type of reproducer.

When the specified resistors are used, and the batteries are at the rated values, the following voltages will be found on the various tube elements (with the volume control at maximum position).

Tube Type	Cath. to C.G. V.	Cath. to S.G. V.	Cath. to Plate V.	Plate Ma.
V1	2.5	95	132.5	7.0
V2	2.5*	27*	50.0*	0.135
V3	12.0	125	115.0	7.5

The voltages marked \* cannot be measured with an ordinary voltmeter—a very high resistance unit is needed.

The General Electric set, which the circuit depicts, covers a range of frequencies from 40 to 1,712 kc. The frequency range, of course, depends on the type of coils and condensers employed. The undistorted output of the set is 0.2-watt.



## All-Wave Aerial Filterizer

is the necessary complement to the modern all-wave receiver to provide best signal reception at all frequencies with relief from all types of man-made static.

COMPLETE KIT—MODEL 34—including aerial transformer, 50 feet transmission line, receiver transformer with waveband change-over-switches, power line filter, aerial wire, insulators, ground clamp, and window lead-in strips—NOTHING MORE TO BUY—\$6.95 list.

Model 35 Kit, same as above except without aerial and ground equipment and power line filter—\$4.95 list.

ASK your jobber or write

TOBE DEUTSCHMANN CORP.  
CANTON MASSACHUSETTS

# Compare!

and your choice is sure to be

## MASTERPIECE II



Compare the engineering facts . . . then compare the actual performance of MASTERPIECE II to other all-wave receivers, custom-built or otherwise. You'll find MASTERPIECE II the only receiver having ALL the features necessary to yield *really enjoyable* reception of European and other far off stations. Read the complete story of MASTERPIECE II in my new book . . . see why Admiral Byrd and others to whom dependable, transoceanic reception is vital, chose MASTERPIECE II. See for yourself why MASTERPIECE II is so good that I can offer it on an unconditional 10 day trial, money back without question. This book is FREE. Send coupon today.

**McMURDO SILVER, INC.**  
3350 N. Paulina Street, Chicago, U. S. A.

McMurdo Silver, Inc.,  
3350 N. Paulina St., Chicago, U. S. A.  
Send free book giving full details of MASTERPIECE II.

Name.....  
Street.....  
Town..... State.....

## HOW TO BUILD, TEST AND REPAIR RADIO SETS



### Radio Construction Library

Including Television, Short-Wave Receivers and Auto Radios. 3 Volumes, 6x9—1177 pages, 561 illustrations. This practical Library includes: PRACTICAL RADIO—The fundamental principles of radio, presented in an understandable manner. Illustrated with working diagrams. PRACTICAL RADIO CONSTRUCTION AND REPAIR—Methods of locating trouble and reception faults and making workmanlike repairs. Discusses modern Short-Wave Receivers and installation of automobile radios fully. RADIO RECEIVING TUBES—Principles underlying the operation of all vacuum tubes and their use in reception, remote control and precision measurements.

Helps you to understand modern type receiving sets—full of construction data and practical kinks for the experimenter—a training course for service men.

10 Days' Free Examination  
Easy Terms

McGraw-Hill

#### FREE EXAMINATION COUPON

McGraw-Hill Book Company, Inc.,  
330 W. 42nd St., New York.

Gentlemen:—Send me the new RADIO CONSTRUCTION LIBRARY, all charges prepaid, for 10 days' Free Examination. If satisfactory I will send \$1.50 in 10 days, and \$2.00 a month until \$7.50 has been paid. If not wanted I will return the books.

Name.....  
Home Address.....  
City and State.....  
Position.....  
Name of Company..... RC-7-34

### TUBE DATA

(270) Mr. Alvin G. Wentworth, Boston, Mass.

(Q.) In looking over advertisements of the Majestic line of tubes, I note several that are not commonly known, and apparently do not correspond with tubes of other tube makers. I refer particularly to the type G-4, the 4-S and the 2-S. Can you tell me what types of tubes these are and if there are comparative tubes made by other manufacturers?

(A.) The Majestic type G-4 tube has no comparative type in other makes. It is similar in filament characteristics with the type 56, except that instead of having a grid and a plate surrounding the cathode, it has two plates concentric to the cathode. This tube is used as a duo-diode or as two separate diode tubes, for detection, A.V.C., etc.

The 4-S, according to Majestic methods of numbering is the same as the G-4, except that the outside of the glass envelope is sprayed with a metal to form a shield for the tube elements. The type 2-S is similar to the tubes mentioned above, except that it has a filament corresponding to the type 27 tube while the filament of the 4-S is the same as that in the type 56 tube.

In other words, the three tubes that you inquire about are all duo-diodes with slightly different filament characteristics and either having the spray-shield or not depending on whether the letter "S" follows the designating number.

### ALL-WAVE RECEPTION

(271) Mr. John Hetzel, Sistersville, W. Va.

(Q.) I recently purchased a G.E. model K-80 All-Wave receiver and was disappointed at the amount of noise I picked up on the short waves.

Knowing the set was a good one and the fault must be somewhere other than the set I started to run through the back numbers of your splendid RADIO-CRAFT for information, and in the January, 1934 number I ran into Hugo Gernsback's editorial, "All-Wave Sets." Everything he stated I found to be just as he found it, and the thing which caught my eye was the "transposition antenna lead-in."

This was not all clear to me so I dug into my files of RADIO-CRAFT and I was rewarded by finding in the September, 1932 number, page 164, an article by Arthur H. Lynch, entitled, "Short Wave Collectors."

I intend to erect such an antenna as soon as possible and I feel sure that I will be amply repaid. I would enjoy reading more about the construction of such antennas and I really believe that, inasmuch as there are, and in the future will be many such set owners, a good article on the construction of antennas suitable for such receivers would be very much appreciated. In fact, a department (not for "hams"—the technical short-wave "transmitting" amateurs) for broadcast listeners who have all-wave receivers dealing in ways and means to improve and to deal with these elusive waves would be well received by a great many of your readers. Here's hoping RADIO-CRAFT will be the first to point out the way to this new and growing family of listeners.

Are there any suggestions you would care to offer that might enable me to improve my all-wave antenna set-up?

(A.) A comprehensive article on all-wave antennas has been written, from a practical point of view, and the first part appears in this issue.

Readers may be interested in checking the input circuit of the G.E. model K-80 receiver, in order to check the operation of a particular antenna arrangement. The model K-80 set appears in RADIO-CRAFT Data Sheet No. 109, in the March, 1934 issue.

We will be glad to print information of special interest to all-wave set owners, provided these owners support their own columns by sending us a little editorial "copy," from time to time, as it becomes available.

Incidentally, this set tunes up to 2,000 meters, but how many readers of RADIO-CRAFT have ever heard any foreign programs on sets of this type, on any wavelength within the range of 550 to 2,000 meters? Tell us.

## INTERNATIONAL RADIO REVIEW

(Continued from page 17)

### SECTIONAL CABINETS

A TYPE of cabinet similar in construction to sectional book cases have found their way into the English radio market. When assembled, these cabinets have a pleasing modernistic appearance, as shown in Fig. E.

They have the additional advantage of being easy to transport, as each part, such as the speaker, chassis, battery box (if battery operation is used) etc. can be handled separately. This is clearly shown in Fig. F, where the cases are "taken down."

These cabinets have all the advantages of the add-on bookcase, as individual sections can be purchased as needed. In other words, the fan can purchase a set and speaker at one time and mount them in two sections. Then later, when a short-wave set, phonograph attachment, extra amplifier or speaker, etc. are desired, additional sections can be purchased to accommodate them, without having to discard the entire cabinet.

### A HIGH-QUALITY SPEAKER

IN Fig. G appears a speaker having a special diaphragm arrangement to permit high-quality reproduction.

A practical demonstration of this type of speaker, used with a P. A. system, recently took place at "Royal Albert Hall" London and according to the accounts in THE WIRELESS WORLD, the reproduction was as near to being perfect as anyone present had heard.

Two speakers of the type shown in Fig. G were used in this demonstration. These speakers use the double diaphragm mentioned before, and are mounted in special 2 ft. horns which are particularly well adapted to voice reproduction.

### A HIGH-QUALITY CARBON MIKE

THE microphone shown in Fig. H is a high-quality carbon unit, designed for professional use. It is a transverse current unit, having a diaphragm 3 3/8 ins. in diameter.

Particular care has been taken to reduce the hiss so prevalent in most carbon mikes, and the description in WIRELESS WORLD says that this annoyance has been reduced until it is barely perceptible. The impedance of the unit is approximately 500 ohms at 100 cycles.

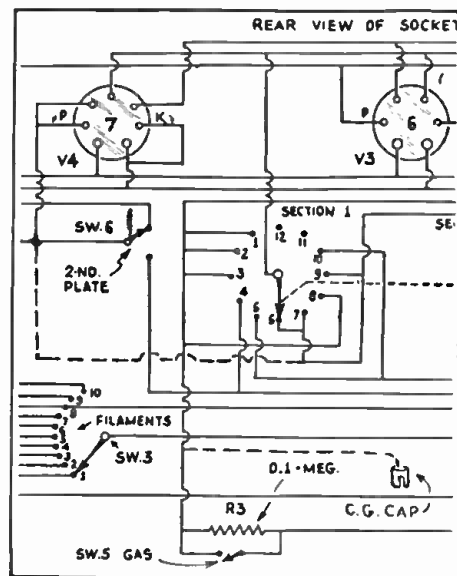

DEPENDABLE TUBE TESTER

THE circuit above is the correct revision for the circuit which originally appeared in the August, 1933, issue of RADIO-CRAFT, on page 86. The correction in the January, 1934, issue was incomplete.



# Concourse Condensers

Used by Servicemen who Know Superior Products



Recently we introduced our "PEE-WEE" WAX TUBULAR CONDENSERS

The Smallest on the Market — NOW —

A Line of High and Low Volt Dry Electrolytics with

Our Usual Super Quality

**BUT IN THE SMALLEST DIMENSIONS**

Ideal for Replacements or in New Sets

Send for our new catalog

**CONCOURSE CONDENSER CO.**

389-409 Wales Ave.

New York, N. Y.

## A NEW AUTO Remote Control

Eliminate mechanical controls. Connect to your amplifier with a 7 wire cable only. Size 3 1/2 x 1 1/2 x 3 1/2. Uses 6A7; 450 KC output. Selective, sensitive, high gain. Calibrated 550 to 1700 K. C. List price \$15; Servicemen's Special Price **\$8.50** Less Tube



Dealers write for discounts. Send a stamp for our descriptive pamphlet and auto radio set diagrams.



**DELTA RADIO MFG. CO.**  
33rd Ave. and Talmadge Ave. S.E.  
Minneapolis, Minnesota

## A NEW Device!

A "CHUCKER" enables radio men to localize any radio trouble, in any radio receiver, in a few minutes right in the field. Successful on 1,000 actual service jobs. Comes complete with instructions and schedule of flat rate prices which you can quote at once regardless of the repair necessary. Flat rate schedule based on \$1.50 per hour for labor and list prices for parts. Price \$1.00. Postpaid.

**FREED'S RADIO CO. (Dept. R)**

5053 Baltimore Ave., Philadelphia, Pa.

## FOR FIXIT SHOPS — ALL FREE

Service Courses in Vacuum Cleaner and Washing Machine Repairing. Thousands of parts for both new and old machines at sensational saving. You can easily increase your income at no extra cost. Hundreds of shops are being benefited by our System.

FREE PROFIT GUIDE TELLS ALL

**URON INDUSTRIES, INC.**

Originators and World's Largest Source of its Sort

1251 W. Sixth Street Cleveland, Ohio

## COMPLETE ELECTRIC PLANTS



**\$99** ONAN A.C. PLANTS furnish same current as city service. Operates Radio, Water System and Household Appliances.

SIZES 300 WATTS UP Models low as \$99. No battery. For farms, lake homes, commercial purposes, public address. Some dealers' territory available.

D. W. ONAN & SONS  
Minneapolis, Minn.

951 Royalston Avenue

## AUTO-RADIO SETS AND FEATURES

(Continued from page 23)

(model B-52). This new portable auto-radio receiver may be used any place in the car as bolting to the firewall is not required. It may be picked up and carried into the house where it performs as readily using A.C. for power as when operating in the car with the 6 V. car battery for supply.

This model has a stream-lined, compact metal case housing chassis, circuit and controls. It may be placed anywhere in the car; on front or back seat, on the floor, or on the shelf back of the seat in coupes and roadsters. It may be operated by driver or passenger with equal ease. The case is sloped to conform to the lines of the seat cushions and may be used as an arm rest if desired. The leather carrying handle can snap down in a recess when not in use. The case is satin-crackle finished in an attractive shade of brown.

The circuit is a 5 tube superheterodyne, one of the tubes being a rectifier which is employed when operating on A. C. When in the car, 4 low-drain auto-radio tubes and a vibrator-type "B" battery eliminator are used. Both tone and volume are of uniform quality on either source of power. Because of the location of the set in the car, affording better distribution of sound, the model B-52 will have better apparent tone and output than previous auto receivers. Both sensitivity and selectivity are excellent.

Service Men will welcome the B-52 for its freedom from installation problems. Installation is simple, there are no problems of "fitting" the set to the car. After installation of the usual ignition accessories, the only connections necessary are to attach the fuse-contained battery leads to the battery and to connect the antenna. In the house, simply attach the antenna, and plug in on any 110 V., A.C. outlet. Separate cord sets are supplied for battery and A.C. operation.

Among the features of the B-52 are its improved automatic volume control, a full-range tone control, and noise suppression. The airplane type, illuminated no-glare tuning dial is calibrated in kilocycles. All controls are conveniently arranged. The on-and-off switch is also used to change from battery supply to A.C. and return. An improved dynamic speaker is used. Chassis and wiring are completely shielded. The set is rubber-cushioned against vibration.

### Majestic Model 66

The Majestic Twin Six auto radio receiver (model 66), shown at C, is an all-in-one unit, the speaker, chassis and eliminator being contained in a metal case 7 x 7 x 12 ins. long. The receiver is suspended on two brackets which are bolted to the bulk-head after drilling 3 small holes. A tone-control knob is located in the lower left hand corner. A "sensitivity" switch will be found on the upper right. When snapped to the right, greater sensitivity and volume result on weaker stations; to the left, excellent local-station reception, together with a considerable reduction in background (or ignition) noise. Jacks for the extension speaker are located on the left side and directly below the cable bracket. The airplane dial is accurately calibrated in kilocycles. Non-glare illumination from a pilot light on the dial indicates when current is passing through the receiver, and acts as warning signal that the set is still in operation when the station has signed off.

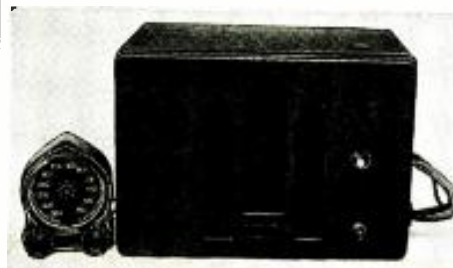

Fig. 1

The 6 tube Postal Model T superheterodyne.

## ANNOUNCING

Two NEW and BETTER Tube Testers!



Readrite  
Nos. 421-422

READRITE announces two new and better tube testers: the No. 421, for the dealer's counter—and the No. 422, a portable unit for the service man . . . out in the field. These improved testers are characterized by many unusual and outstanding features that give a new conception of tube tester performance. They are so simply designed that anyone, without experience, can operate and understand them.

These testers incorporate a 3/2" Triplet Precision Meter, which has a shaded two-color scale. It indicates in simple English that the condition of the tube is either "good" or "poor." No longer need you reassure skeptical customers as to the worth of tubes that you are testing for them.

A line voltage control A.C. Meter is also incorporated, which tests cathode and grid shorts. A simple push button provides two-plate current readings for determining the worth and conductance of all types of new and old tubes.

## Your Jobber Can Supply You

. . . with the No. 421 (counter tester) at the dealer's net price of \$24.00—and with the No. 422 (portable tester), at the dealer's net price of \$25.50. These testers come in a beautiful quarter-sawed oak case.

**Readrite Meter Works**

116 College Ave.

Bluffton, Ohio



SEND COUPON FOR FACTS!

READRITE METER WORKS,  
116 College Ave., Bluffton, Ohio.

Gentlemen:

Send me a catalog on Readrite Tube Testers, and your complete line of radio servicing equipment.

Name .....

Address .....

City.....

State.....

# Train Now for New RADIO Opportunities

Get Into a Line Where There's Action—Every Day—And a Payday Every Week—You Be the Boss!

**Analyzer & Resistance Tester—Latest Design—YOURS Without Extra Cost**

Right now while hundreds are looking for work where there isn't any, the radio service field can use trained men. With the proper training and the necessary equipment, you can enter this field and make a comfortable living. We include with our course this modern set analyzer and trouble shooter without any extra charge. This piece of equipment has proved to be a valuable help to our members. After a brief period of training, you can take the set analyzer out on service calls and really compete with "old timers." We show you how to wire short-wave receivers—analyze and repair all types of radio sets—and many other profitable jobs can be yours. Teaching you this interesting work is our business and we have provided ourselves with every facility to help you learn quickly yet thoroughly. If you possess average intelligence and the desire to make real progress on your own merits, you will be interested.

## ACT NOW—MAIL COUPON

Start this very minute! Send for full details of our plan and free booklet that explains how easily you can now cash in on radio quickly. Don't put it off! Write today. **SEND NOW!**

**RADIO TRAINING ASSN. of AMERICA**  
Dept. R-7, 4513 Ravenswood Ave., Chicago, Ill.  
Gentlemen: Send me details of your Enrollment Plan and information on how to learn to make real money in radio quick.

Name .....  
Address .....  
City ..... State .....

## Build Your Own Wheatstone Bridge For \$41.50

A simple, rugged, wide-range Wheatstone Bridge for resistance measurements. Operation identical with best laboratory instruments. Sensitive, accurate. Low cost. Kit easily assembled.



SHALLCROSS No. 630 Kit \$41.50  
Assembled \$49.70

Built around a highly sensitive galvanometer and Shallcross Resistors. Range .01 ohms to 11.1 megohms. Send 6c in stamps for Bulletin 630-P.

**SHALLCROSS MFG. COMPANY**  
Electrical Measuring Instruments and Accurate Resistors  
700 MAC DADE BOULEVARD  
COLLINGDALE, PA.

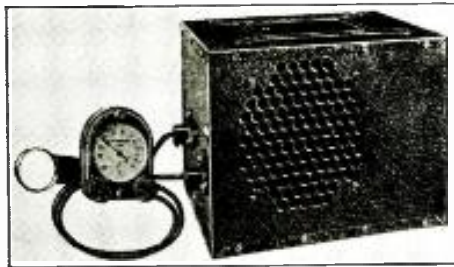

Fig. J  
Crosley 6 Tube Model 103 Set.

The control unit that mounts on the steering column is direct-drive connected to the receiver case by heavy flexible shafts, eliminating back-lash and slipping. The volume control knob acts as on-and-off switch and key, and when removed locks the receiver.

### Arvin Model 25

Enclosed in one case are the radio chassis, speaker and "B" power unit, as shown in Fig. D. Size 8 x 8 3/4 x 8 1/2 ins. deep. The case is finished in black morocco with chrome-plated grille front. The set is equipped with a 6 in. electro-dynamic speaker; also, an 8 point tone control, regulated by a knob on top of the tuning dial. The distinctive remote control clamps on steering column and makes tuning fast and easy. The set uses an extremely selective circuit, inter-channel noise suppression, and automatic volume control. Tubes used: two 78s, and one (each) 6A7, 41, 84.

### Motorola Model 34

This 6 tube superheterodyne receiver, Fig. E, has the following features: all-electric, 3 gang tuning condensers, tone control, indirectly-illuminated airplane dial, key lock switch, full dynamic speaker. It utilizes the following tubes: two 78s, and one (each) types 77, 75, 42, and 84. The radio set, speaker, and "B" power supply are in one unit. Size, 10 1/2 x 6 x 5 1/2 ins. high.

### Audiola 346

This receiver is a 6 tube superheterodyne using a most modern combination of tubes. The receiver and remote control are shown in Fig. F. The tubes are: one (each) types 6D6 (R.F. amplifier), 6A7 (combination first-detector and oscillator), 6D6 (I.F. amplifier), 75 (diode second-detector, delayed A.V.C., and 1 stage of A.P. amplification), 41 (power output), and 84 rectifier.

The design of the set is such that, the manufacturer claims, no suppressors are necessary for ignition noise elimination. However, the installation otherwise must be as complete in regard to grounds and shielding as ordinary good installation procedure would require. The disadvantages of the average suppressors, in regard to motor efficiency, are sufficient to warrant any extra work necessary to eliminate the need for them.

### Studebaker-Philco Auto Radio

In Fig. G is shown a receiver manufactured by Philco especially for the Studebaker Company. It is a 6 tube superheterodyne of modern design but with special fittings (tuning control arrangement) so that it may be

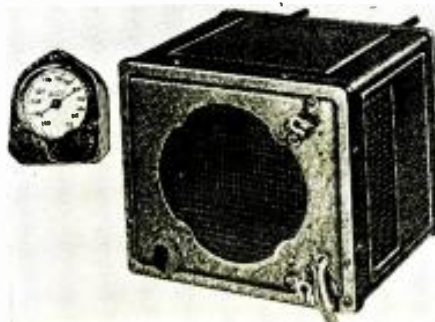

Fig. K  
The Zenith Model 462 Receiver.

readily installed in Studebaker cars, and blend with other instruments on the dash. See Fig. M.

### RCA Victor M-105

A receiver which features mechanical simplicity in construction and design is shown in Fig. H. Only the following 4 tubes are used: one (each) type 78 (R.F. amplifier), 6A7 (first-detector and oscillator), 6B7 I.F. and second-detector, and 41 (power output). A combined mechanical vibrator and mechanical rectifier inverter eliminates the necessity of a rectifier tube. The circuit employed is of superheterodyne design.

### Postal Model T

This auto set, Fig. I, is a 6 tube superheterodyne, which tunes from 100 to 555 meters, one-unit construction, and single-hole mounting. The 6 tubes employed are: one (each) 6A7, 75, 41, and 84 (rectifier tube), and two 78s. Power consumption is rated at 4 A, from the storage battery.

There are a considerable number of other good auto receivers, any of which have novel features which are worthy of description in these pages. Unfortunately, due to lack of space it is impossible to mention all of these sets. However, as manufacturers announce new models we attempt to list and describe them, from time to time, in our department. **THE LATEST RADIO EQUIPMENT.** To the Service Man, dealer, or any others who may be interested in new auto sets, features, and wiring diagrams we offer the suggestion that they watch these pages. In addition to our **DATA SHEETS**, for new information.

### Crosley Model 103

This receiver is a 5 tube superheterodyne designed for operation from a 6 V. automobile storage battery. The "B" voltage is furnished by a Crosley Synchronode. The I.F. used is 181.5 kc. See Fig. J.

The following are the tubes and voltages measured with the receiver in operating condition but with no signal to the antenna, and with a battery voltage of 6.3 V. All voltages are measured from tube contact to chassis with a 300 V. D.C. voltmeter (1000 ohms per volt).

Tube Type	Plate Volts	S-G. Volts	Cath. Volts	Sup-G. Volts
78 R.F.	210	100	2	2
78 Osc.	210	100	28	0
6B7 I.F. Det.2.	210	100	2.5	—
78 A.F.1	50	20	2.0	2
41 output	195	210	16.0	—

The "A" circuit of this set is fused in the "hot A" lead with a 10 A. fuse. A dynamic reproducer is used; its field current is derived from the "A" supply. Need for a rectifier tube has been eliminated by the use of a vibrator-type "B" unit that utilizes the self-rectifying principle. Through the use of a stage of R.F. amplification ahead of the combined first-detector and oscillator, image-frequency reception is reduced to minimum. The two plates of the diode portion of the type 6B7 tube are utilized only for obtaining the A.V.C. action.

### Zenith Model 462

This auto set employs 6 tubes, utilizes a superheterodyne circuit (see diagram pages), and is simple to install. Provision is made in the design of the set, for rear mounting (under the bulkhead) so that the speaker faces the occupants of the car, or for side mounting (most convenient in some cars) so that speaker faces across the car. Three holes, 1/2-in. in dia., are necessary for installing the receiver which includes, in one unit, receiver chassis, speaker and "B" power supply. See Fig. K.

A tone control is included in the set, the adjustment of which not only will correct the depth or pitch of reception to that desired by the user, but will also serve to modify all ignition noise interference which may tend to "leak" through.



RCP • RCP • RCP • RCP • RCP • RCP

The Ideal, Compact Tester  
for AUTO-RADIO and General Use

## Model 403 Multitester



2,000 ohms per volt. Accuracy within 2 percent, and adaptability for all future needs assured, at low cost, by this new Model 403 MULTITESTER. UNUSUAL type moving coil, 3-range 0-2,000,000 ohmmeter, 4-range 15-50-250-750 voltmeter. A microammeter 0-500, for small photo-cell and grid measurements. Cry-talline bulb case, only 5 3/8 x 2 3/4 inch panel. Complete, with self-contained batteries. NET \$14.95 to Dealers and Service Men. List \$37.50. KIT FORM \$10.95 NET. List \$27.50.

Write Dept. RC-7 for FREE Data Sheets on Radio City Products.

**RADIO CITY PRODUCTS CO.**

48 WEST BROADWAY, Dept. RC-7, NEW YORK, N. Y.

RCP • RCP • RCP • RCP • RCP • RCP

## POSTAL BOOSTER



**GUARANTEED TO IMPROVE S.W. RECEPTION**  
(As Described in the June Issue of Radio-Craft)

The Postal BOOSTER is a self-powered two-stage tuned H.F. Pre-selector unit employed to increase the range and selectivity of any short- or all-wave receiver. It eliminates repeat spots (image frequencies) and reduces background noise. Sold on trial—with a money-back guarantee. Send for Free Booklet "8 Ways for Better Short-Wave Reception."

**POSTAL RADIO**  
135-K LIBERTY ST. NEW YORK, N.Y.



**Brand New \$3.95**  
Volt-Ohm-Milliammeter  
Basic 0-1 Milliammeter 50 M.V.  
—1000 ohms per volt. 3 1/4 inch case. **GUARANTEED. BUILD YOUR OWN TESTER.** Complete plans with each instrument.

**UNIVERSAL METERS \$6.95**  
A.C.-D.C. Rectifier Type  
Complete with Rectifier

Special prices on wire wound 1% accurate resistors. Send for bulletin. PRINTED DIALS on brass back plates for UNIVERSAL and OHMMETERS ALL TYPES, 45 cents each. Automote Mfg. Co. 83 W. Van Buren St., Chicago

## NEW! SENSATIONAL! 110 VOLTS AC FOR AUTOS

The new AUTONATOR generates 110 Volt A.C. Current in motor cars, aeroplanes and from all types of engines and motors, direct from fan belt. Costs nothing to operate. No service—no brushes, collector rings, commutator or wire wound armature. Ideal for operating PORTABLE Sound Equipment, A.C. Radio Sets, Neon Signs, Electric Lights, Searchlights. Send for complete details.

**AUTONATOR LABORATORIES, INC.**  
8440 South Chicago Ave. Dept. A Chicago, Ill.

## TODAY'S PROFIT OPPORTUNITY

**INVESTIGATE MOTION PICTURE SOUND**  
Buy From the World's Largest Suppliers  
Exceptional Bargains in New, Used and Rebuilt Motion Picture Apparatus. Recent Government Surplus and Liquidation of other manufacturers such as PACENT, ROYAL AMPLITONE, POWERS CINEPHONE, TONO-GRAPH, BIOPHONE, RCA PHOTOPHONE and others now offered to our trade.

Write for Our Latest Illustrated Catalogues  
**S. O. S. CORPORATION**  
Dept. RAC 1600 Broadway, New York, U.S.A.  
EXPORT: 120 Liberty St., New York  
CABLE ADDRESS: "80SOUND" New York. All Codes.

## "HOT" FIELD COIL PRICES AND RADIO PARTS

**RAUCH RADIO ELECTRIC**  
Magazine at Eleonore St., New Orleans, La.  
Gentlemen: Rush me your Catalogues.  
Name .....  
Address ..... State.....

## RADIO MONTH IN REVIEW

(Continued from page 7)

hotel permits four program to be selected by the guests in any room of the hotel, as well as the music of orchestras playing in the hotel restaurants and ball rooms. Another contemplated advantage to the management and the guests alike is the feature permitting the announcement of events of interest and features to take place in the hotel, so that all may hear.

It is interesting to note that the new methods and equipment used in this installation were developed by an organization that specializes in this type of sound installation, and have materially reduced the cost. For example, the cost of installing such a centralized radio system in an 800 room hotel was previously about \$45,000 while with new methods and equipment, as worked out by the engineers who installed this unit, the cost would be reduced to the very low figure of about \$18,000. The installation time has also been materially reduced—in the instance of the example given above, about one month compared to five months previously. Since repair-maintenance costs are only about \$200 per year, we see that it isn't the "upkeep," but the "initial cost" with which hotel managements are concerned.

All these facts are interesting to the professional radio man when it is realized that only about 10 per cent of the hotels are equipped at present, which opens up a new field for the P.A. engineer.

## RADIOPHONE AIDS FOREST RANGERS

**R**ADIO equipment has been used for some time by the Forest Rangers who patrol the national forests. However up to the present, the portable equipment carried by the rangers has been limited to radio telegraph types, which limited their usefulness, and the speed with which communication could be carried on, and required a special "operator."

In preparing for the usual summer rush of tourists, campers and other vacationists, who generally cause a great many summer forest fires, the rangers this year have brand new shiny radio telephones, one of which is shown here. These new combined transmitters and receivers were shown for the first time last month, and it is expected that they will be much more satisfactory for the "smoke chasers" than the previous equipment.



PORTABLE RADIO TELEPHONE  
To aid "smoke chasers" in their work.  
(Photo. Dept. of Agriculture)

# NEW KIND of Sylvania Service Book



### TABLE OF CONTENTS

	Page
GENERAL ENGINEERING INFORMATION	5-7
INSTALLATION	
Automobile Battery Grounds	8-9
Antenna Installation	10-14
Top Construction	10-14
Running Board and Under-Car	13
Automobile Antenna Equipment	14
INTERFERENCE SUPPRESSION	15-23
SERVICE HINTS	
By Makes of Receivers and Cars	24-37
I. F. Peak Frequencies	
MISCELLANEOUS INFORMATION	
TUBES	

**FREE**  
to you  
Clip coupon

Now Sylvania engineers have prepared a reference book on auto-radio. This handy pocket manual contains tested information on suppression of ignition interference, 6 types of antennae and their installation, the R.M.A. Resistor Color Code Chart of tube types and other important data you will need in auto-radio servicing.

Send for your free copy. It will help to put you in on the ground floor of the fast-growing auto-radio industry... that Sylvania engineers themselves promoted with their development of the 6.3 volt tube.

### HYGRADE SYLVANIA CORPORATION

Makers of  
SYLVANIA TUBES  
HYGRADE LAMPS  
ELECTRONICS DEVICES  
© H. S. Corp., 1931

Factories  
ST. MARY'S, PA.  
EMPORIUM, PA.  
SALEM, MASS.  
CLIFTON, N. J.

**Sylvania**  
THE SET-TESTED RADIO TUBE

HYGRADE SYLVANIA CORPORATION  
Emporium, Pa. B-12  
Please send free, without obligation, your new service book "Auto-Radio Installation and Servicing."  
Name .....  
Address .....  
City..... State.....

*Dependable Sensational Performance!*

## BUD

Laboratory-Built  
P. A. Equipment

**5 DAYS FREE Trial**

Try BUD Sound Equipment For Five Days Absolutely Free!

ELECTRO-DYNAMIC UNITS  
CARBON AND CONDENSER  
MICROPHONES - 4 & 6 FT.  
ALL ALUMINUM TRUMPETS  
FIELD EXCITERS - AIR COLUMN  
HORNS - LOW AND HIGH  
FREQUENCY UNITS FOR WIDE  
RANGE THEATRE USE

WE invite careful, critical inspection of our entire line of BUD laboratory-built sound equipment. We suggest that you conduct your own comparative test. We CHALLENGE you to duplicate BUD performance and BUD DEPENDABILITY AT ANY PRICE! Write today for descriptive literature and prices and details of our FREE FIVE DAY TRIAL offer.

**BUD SPEAKER CO.**  
1114 JACKSON ST.  
TOLEDO, OHIO - U.S.A.



## Eliminate Auto-radio "B" pack troubles

Install the new low price Pioneer Gen-E-Motor Replacement Unit to stop auto-radio vibrator type eliminator troubles. Guaranteed for ONE YEAR. No adjustments. No lubrication. Also new Pioneer Gen-E-Motors for sound trucks, etc. Write for Catalog.

Model J.W. Gen - E - Motor, list \$13.00

## Pioneer Converters

6-12-32-110 volts D.C. to 110 volts A.C.

New heavy duty D.C. to A.C. converters. Remarkably low in price, yet designed for continuous duty. A size for every need, including Neon sign and other electrical appliance applications.

Ask your Jobber or write  
PIONEER GEN-E-MOTOR CORP.  
460 W. Superior St., Chicago, U.S.A.

## ELECTRAD

### Replacement VOLUME CONTROLS

are instantly interchangeable to use power-switch without disturbing control connections. Only 5 types needed to service 799 standard receiver models.

Write for New Catalog "RC-7"

175 Varick St., New York, N.Y.  
**ELECTRAD**

## FREE! NEW RADIO CATALOG

Packed with new-model radio VALUES at rock-bottom wholesale prices. Money-back guarantee and 30-DAY FREE TRIAL IN YOUR HOME on every set! All types. Send for big, new FREE catalog \$9.45 Up TODAY. Prices.....

FORDSON RADIO, Inc.

Dept. 7-38, Oakman Bldg.

DETROIT, MICH.

## A SET SENSITIVITY TESTER

(Continued from page 19)

for the average set, and 100 mmf. for old or insensitive receivers.

A small  $1\frac{1}{2}$  V. cell is sufficient for operating the filament of the 30 tube, since, as mentioned previously, a strong R.F. output from the oscillator is not really necessary. The complete oscillator must be shielded, as most oscillators are or should be, to avoid stray radiations from affecting any tests or measurements that are to be taken.

The construction, assembly and wiring are so simple that no further details than those shown in Figs. A, B, 1, and 2 are necessary. Layout of parts, and appearance are shown in the first two mentioned illustrations. Wiring diagram and coil construction are shown in Figs. 1 and 2.

Parts necessary, with the exception of meters, will be found in the junk box that most constructors always have.

### Calibrating the Oscillator

By tuning-in various broadcast stations on a standard receiver of good design, accurate frequencies are available, especially from crystal-controlled broadcast stations; these are used for calibrating the oscillator. The simplest procedure is to first plot an accurate calibration curve of the broadcast receiver. Such a curve is illustrated in Fig. 3. Frequency in kc. is plotted against tuning dial settings.

The first step is to disconnect the aerial from the broadcast receiver and connect the insulated output post of the oscillator to the aerial post of the receiver and connect the other post to the ground of the receiver. By switching on the oscillator, a series of harmonics may be heard by turning either the oscillator dial or the broadcast receiver dial. We are now prepared to make a very accurate set of calibration curves of the oscillator, after which the calibration can be further checked by heterodyning with crystal-controlled broadcast station waves.

The next step is to set the oscillator dial at its maximum or 100. Then tune in a harmonic of the oscillator at the highest dial setting heard on the broadcast receiver. Turn the volume-control of the oscillator until the harmonic signal is very weak and an accurate dial reading of the receiver is obtained. On this particular set, a harmonic was heard at 87 on the receiver dial. This indicated, from Fig. 3, a frequency of 593 kc.

Now slowly decrease the tuning dial setting of the broadcast receiver (leaving the oscillator setting as it was) until another harmonic is heard. In this case one was heard at 70 on the receiver dial and from Fig. 3 indicated a frequency of 711.5 kc. The former figure subtracted from the latter, or 711.5 minus 93, equals 118.5. This is the fundamental frequency of the oscillator because each harmonic differs from adjacent ones by an amount equal to the fundamental.

We can check the accuracy by dividing 593 by 118.5, which gives 5 and a slight amount over indicating that our readings were not exact. Evidently we were working on the 5th and 6th harmonics. Dividing 593 by 5 gives 118.6 as the fundamental. Six times 118.6 would give a frequency of 711.6 for the 6th harmonic instead of 711.5, which was obtained from the curve.

Knowing that the fundamental frequency is 118.6 at the 150 degree setting of the oscillator dial, we can mark off on the calibration chart, Fig. 4, harmonics up to the 12th, spaced 118.6 kc. apart.

The same procedure can be carried out at the zero setting of the oscillator dial. In this case the frequencies worked out accurately at the first trial. A harmonic was tuned in at 72 on the tuner dial, indicating a frequency of 700 kc., and at 43, indicating a frequency of 1,050. The difference, 350 kc., is the fundamental frequency of the oscillator at this setting. The second, third and fourth harmonics are marked on the graph of Fig. 4. This procedure was carried out at every 10 degree setting of the oscillator dial. A series of curves, as shown on the chart of Fig. 4 were plotted. It was found that the curves were actually straight lines, due to the straight-line-frequency char-

acteristic of the oscillator condenser.

If one desires very accurate readings, the output meter should be connected to the radio receiver so that a visual indication, rather than an audible one, may be had. A suitable output meter is shown in Fig. A, and is also necessary for checking the efficiency of a receiver, aligning T.R.F. and I.F. stages, besides other uses for the oscillator which will be described shortly.

To make an accurate check of the calibration curves of the oscillator, one of the side plates should be removed and a piece of wire connected across the grid condenser so as to short-circuit it. Then the side plate should be replaced. In this condition the oscillator will generate a non-modulated wave which can be used to heterodyne the wave of a crystal-controlled station tuned in on the receiver. When making this test a short indoor aerial, just sufficient to pick up the broadcast station, should be connected to the aerial post of the receiver. The oscillator is left connected to the receiver. By tuning-in a station, such as WOR at 710 kc., the oscillator should cause a heterodyne squeal at 73, 112½, and 135½ (dial settings of the oscillator) working on the third, fourth and fifth harmonics respectively. Tune the oscillator dial for zero-beat adjustment and the calibration will be exact. Several stations may be tuned-in in this manner and slight corrections can then be made to the previous plotted curves if necessary, after which the short-circuiting wire connected across the grid condenser may be removed.

### Uses of Set "Tester"

For determining the sensitivity of a receiver with this unit it should be first stated that the procedure is by no means completely accurate and from an engineering angle not of the best. But, for all practical purposes, providing all measurements are taken carefully and the data compiled for reference and comparison, this method and equipment can actually advise the Service Man how efficient the receiver is as compared to any good radio receiver that may be chosen as a standard.

By referring to Fig. A an approximate idea as to the set-up may be obtained. The output terminals of the oscillator are connected to the antenna and ground terminals of the receiver. The output meter is, of course, connected across the primary of the output transformer of the speaker, leaving the speaker "in" or "out" of the circuit depending upon whether a "sound" indication is desired in addition to the meter indication. However, for inefficient receivers it would be best to disconnect the speaker since a great deal of energy is absorbed and dissipated in the speaker, resulting in an output indication that would be difficult to read.

The oscillator plate current must be adjusted (with the rheostat) so that it is precisely the same amount as that current which was fed to a "standard" receiver, and whose output figures are to be used as a criterion. All conditions must be exactly alike—the dial readings on the oscillator must be set at precisely the same figure every time a test is to be made. Similarly, the receiver must be exactly in tune with the oscillator. The volume control on the receiver should be at maximum in every test, and the tone control (if any) set to maximum treble. Readings should be taken at 3 points on the oscillator dial, at 200, 250, and 350 meters so that the receiver is checked thoroughly at the low, medium and high wavelength ends. Thus, the procedure after all connections are made would be—set oscillator dial on desired frequency, turn the oscillator switch "on," tune receiver dial until maximum output on output meter is indicated.

Adjust plate current of oscillator to as low a figure as will produce a sizeable output indication on the output meter. Note all readings. Repeat until three frequencies are covered, as mentioned. Check readings with those obtained from some well known efficient receiver. After some practice the user will be able to quickly compare the figures, mentally, and correctly gauge how sensitive the set that was checked will be.

Caution: always use high scale on output meter, unless output is so low that a smaller scale must be used. In this case multiply reading by scale ratio to compare readings.



### Testing Tubes

To find weak tubes in a receiver, the connections are the same as for testing receiver efficiency. Adjust oscillator for low plate current and note output meter reading. Then remove one tube at a time from receiver, replacing with new tubes, and note when each change is made whether output meter reading increases. When a weak tube is replaced a sizeable increase in output reading will be noticed.

### Comparing Receivers

Employing the procedure outlined for testing sets, first check one receiver and observe the 3 output readings for high, medium and low frequencies. Maintaining same plate current reading of oscillator, check the second set for the same frequencies and compare readings. Be sure that tubes in both receivers are O.K., or the results obtained will not be truly indicative of the receiver's capabilities.

### Conclusion

Numerous other uses for an instrument of this type will of course suggest themselves to the Service Man, as he continues to employ it. Further information in regard to applications of an oscillator, which, of course, will also apply to this unit, has been given in complete detail in previous issues of RADIO-CRAFT.

### List of Parts

- One special coil of two windings (details for construction given);
- One I.C.A. variable condenser, 500 mmf.;
- One I.C.A. rheostat, 40 ohms;
- One Cornell-Dubilier bypass condenser, 0.5 mf.;
- One I.C.A. fixed condenser, 500 mmf.;
- Two I.C.A. fixed condensers, 50 mmf.;
- One I.C.A. 4 prong socket (base mounting type);
- One vernier dial;
- One I.C.A. R.F. choke, 8.5 mhy.;
- One 1 1/4 meg. resistor;
- One Triplett 0-1 ma. milliammeter;
- One Triplett 0-2.5-5-50 output meter, model 325;
- One I.C.A. shield can, 12 x 6 x 6 ins. high;
- One 1 1/2 V. dry cell (small size, or tapped "C" battery; 4.5 V. type will do for short quick tests) for "A";
- One 22 1/2 V. "B" block.

## UPLIFTING THE SERVICING PROFESSION

(Continued from page 29)

other resistors connected so you can obtain any value from 300 ohms to 10 megohms by using plug-in plus. Below this main panel is a long, narrow panel for power supply to sets on test and also has aerial and ground post. The same panel is duplicated just under the top of the bench so you can connect up a set which has been installed in its cabinet. On each side of this test panel you will notice two instruments: the one on the left is an up to date test oscillator. On the right is a universal test meter. To the right of the bench you note the P.A. rack with a radio chassis. This is for shop use and rental service as well, also used for a medium of shop advertising. This has proven to be a very important piece of appliance and well worth the cost. The size of this rack is 12 x 20 x 43 ins. tall and made to fit into a car or truck. To the right of this P.A. rack you will see a magazine and book rack that is worth its weight in gold: it allows you to have information at your finger tips. To the right along the wall, you will notice a workbench—on the end of which you will notice an air compressor which is the greatest help I have ever had. This is very useful in cleaning a set, touching up in refinishing or cleaning other work or machinery. A number of the illustrations referred to have appeared in last month's RADIO-CRAFT. Those on the P.A. rack will appear in the forthcoming issue. It is suggested to those interested that when the entire series is completed the articles and diagrams be referred to again for complete continuity.

# NATIONAL UNION TUBES WILL HELP YOU STAR IN SERVICE WORK



### A STAR SERVICE BENCH

The fine example of a modern service bench shown above belongs to Sutely Radio Shop, Oskaloosa, Iowa. Mr. Sutely says:

"Two years ago I was about to give up service work because every time a new tube or set came out I had to buy new test equipment.

"Then National Union came along and showed me their proposition. My first contract was a tube tester and I was first to have one up to date. Therefore, I got the tube business. Then I got more instruments on contract. People soon found out I had the best test equipment and in came the repair jobs. Today I have every instrument and manual that National Union gave out. Also have the finest equipped shop in this city. (Thanks to National Union).

"Still better. I don't have to make repeat service calls to replace tubes like I used to. I have only replaced two bad tubes in the last two years. Think of the time and cost it eliminates a serviceman, not saying anything about dissatisfied customers.

"N. U. will positively test better than any other make and with the ten cents higher list, well, it just means more money for the service man".

**NATIONAL UNION JOBBER STOCKS ARE COMPLETE.**

## Free Meters — Manuals — Superior Quality—More Profit

You want to be rated as a service man who "knows his stuff"! You want to be the leader in service work in your locality. You are given a real chance to star in service work when you tie up with the National Union program. Thousands of your fellow servicemen all over the country are finding that National Union means far more than—radio tubes. Service aids, Sales Aids, Superior Quality tubes. More Profit on every tube sale through ten cent higher list prices. No Price Cutting and Customer Satisfaction are a few of the reasons you can't afford not to tie up with National Union.

To star in service work you need not only superior tubes but complete data and shop equipment. National Union understands the problems of service men and offers FREE with National Union tube purchases a Servicing Tool Kit, Supreme 333 Analyzer, Four Service Manuals, Auto Radio Manual, Triplett 419 Tube Tester, Triplett 1178 Perpetual Tester, Hickok Diamond Point, Jr. Tester, Supreme 85 Tube Tester. All offers subject to withdrawal without notice. Small deposit. What do you need to help you star in service work? Get details!

National Union Radio Corporation of N. Y. RC-7  
400 Madison Avenue,  
New York City.



Gentlemen:

I am interested in:

Name .....

Street .....

City .....

State .....

## THE WHOLE WORLD *is mine* WITH THE TROPHY WINNER "3"

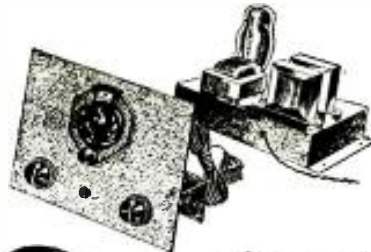

Here is a really superior Short Wave Receiver. Its performance is the

kind you usually associate with only the most expensive sets. Yet the cost is low... just a few cents more than most 2-tube kits. No wonder it has been acclaimed editorially by Short Wave Craft, Short Wave Radio Magazine and the N. Y. Sun! And how easy it is to build! All parts are so placed that a minimum of soldering and wiring is required. Such design cuts down the chances for error in wiring!

### Special Power Pack Kit

The Trophy Winner "3" comes with power supply kit including chassis, power transformer; employs 3 mfd. filter condensers; two 30 henry filter chokes... all over size. Output: 250 V. at 5 MA. Operates from an AC house current and is free from hum.

- CN 13905—Trophy Winner "3" A.C. kit of parts complete with wiring diagram, less coils, tubes, power supply ..... **\$9.95**
- CN 13906—Power supply kit of parts, less tube ..... **4.95**
- CN 13985—Complete kit of parts. Set, power supply, coils and tubes ..... **18.45**



### Brand NEW Catalog!

Truly a Who's Who of Short Wave Royalty: National, Hammarlund, Lafayette, Lynch, etc. Every leading manufacturer is listed here.

Every conceivable Short Wave accessory may be found at Lowest Wholesale Prices! Never before has such an amazing array of Short Wave been packed between the covers of a single catalog. This NEW Bargain Book lists everything including sets and kits from 2-6 tubes, all-wave receivers, condensers, coils, converters, chokes, crystals and holders, transmitting tubes and equipment antenna systems, etc. . . . all at LOWEST WHOLESALE PRICES.

WHOLESALE RADIO SERVICE CO.

100 Sixth Ave., Dept. C-74

New York City.

Send me your New Short Wave Catalog 55D.

Send me the items I have listed in attached letter.

I enclose \$..... to cover cost.

Name .....

Address .....

City .....

State .....

**WHOLESALE RADIO SERVICE CO.**  
100 Sixth Avenue, New York, N.Y.  
New Branch  
219 Central Avenue, Newark, N.J.



# CLAROSTAT

since 1920, The Profit Line

Replacement Volume and Tone Controls  
Standard Volume and Tone Controls  
with an Ad-A-Switch consisting of  
wire wound (Series "W"), composi-  
tion element (Series "C")

Replacement Line Ballasts  
Automatic Line Voltage Regulators  
Flexible Pig Tail Resistors  
Center Tap Resistors  
"L" Pads, "T" Pads, Series Mixers

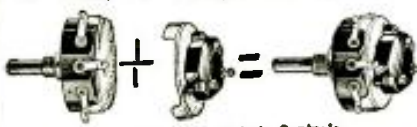

Clarostat Ad-A-Switch Controls



Clarostat Ad-A-Switch line  
comprised the maximum util-  
ity with minimum stock in-  
vestment.

Write for New Replacement  
Control Guide

Clarostat Mfg. Co., Inc.  
287 N. 6th St., Brooklyn, N. Y.

## A RADICALLY NEW TUBE TESTER

NOTE FEATURES AND UNEQUALLED  
PRICE OF THE 22

1. Neon leakage and com-  
plete short test auto-  
matic.
2. Line voltage regulation.  
—Plate and filament.
3. English reading scale.
4. Tests all tubes. Pro-  
visions for future types.  
New tubes can be  
added without remov-  
ing instrument from  
case.
5. AND allows capacity  
tests good—bad—leak-  
age (vacuum tube volt-  
meter principle)
6. Resistance measure-  
ments 500 to 2 megs  
wide separation.
7. Continuity tester on  
neon or meter.
8. Vert. chrome lettered  
bakelite panel.



**\$22.50**

This tube tester and shop tester for  
a price of only \$22.50.

10 days trial—money returned if not satisfactory.

**L & L ELECTRIC COMPANY**  
Dept. 10-A  
336 MADISON AVE. MEMPHIS, TENN.

## Lavender and Lace

Lovely in bygone days—  
as old-fashioned now as  
an ordinary radio aerial



Whether you have a broadcast, short  
wave, automobile or all-wave re-  
ceiver, you can get clearer, more  
realistic, noise-free radio reception  
by the use of the

**NOISE-FREE  
ANTENNA SYSTEM**

Unconditionally guaranteed to out-  
perform any other kind of aerial or  
so-called aerial eliminator, or money  
refunded without question.

Write TODAY for Full Details

**Remember—  
No Radio Can Be Better Than Its Aerial**

ARTHUR H. LYNN, Inc. 327 Fulton St., New York, N. Y.

Next you come to the counter. This is to receive sets for repairing and other purposes. Note the tube checkers on this counter and last, the machine table which is a valuable adjunct as a drill press, grinder and saw certainly come in handy. Also, later a lathe might be added.

This constitutes the shop half of the store, while the other half takes care of the merchandise and display case, shelves and office desk. Back of the partition on the drawing showing the shop, arrangement has been made for storage or what-have-you.

In regard to hand tools, I am not going to suggest here what to have as your own personal needs will supply these but I will comment upon them in this way:

Buy good tools, use them properly and take care of them. Keep them shining! Also keep them (most of them) on the back of the work bench. This is not only for handiness but for display as well and also fits into our scheme of appearance. Men, particularly when they come into a shop, whether they are mechanics or not, have a fascination for tools and it produces a great psychological effect.

### Records of the Shop

The matter of records now comes to our attention. The system explained here is not in reference to bookkeeping but a routine to follow. I use a book and start out with a numerical numbering from one (1) on. When a job comes in, I place the name down in this book and the consecutive number following the name. Then I take a special printed pad and fill it out in triplicate; one for the bench; one for the office and the other for the customer. This last copy acts as a statement as well as a work order and when the job is completed, I see that the book-keeper's sheet is completed the same as the bench copy and file the two with the book-keeper, who in turn keeps the record. When the set is finished I place the guarantee tag on it together with the customer's bill.

I use the above form for everything done in the shop—be it for purchasing material, as a requisition, or for any improvement to the shop, and for estimating too. If this is followed out precisely, it will give a complete record of every move made. This also allows for a record for future reference, and a customer can come in any time and you know just what was done.

I use two color tube labels—one color for the customer's old tubes in the set and the other for the new tubes I sell. So if a customer calls up and says the new tube I put in her set does not work, I ask the color of the label. If it's the color for the old tube, well then that lets me out. Should it be the color for the new tube I ask her to bring it in and if the tube did not hold up within the guarantee period, I replace it without a question.

Whenever I repair a set I tack a business card inside the set so that the customer will know my phone number and address. I also use a filing card system for every customer who's radio set I serviced. I obtain the age of the set and how many times it has been serviced (whenever possible) so that I can see how the set is holding up and when the set has seen its better days. I also notify the customer when I have received so many service calls on the set and I think that the set is just an expense to them. Then these cards are placed in another file and any firm selling radio sets has the privilege of going through this file for future prospects. This requires very careful handling but may be done in such a way that it won't react upon your shop—either to the customer or to the dealers.

### T-T-T Instead of S-O-S

Geneva: The well-known SOS signal may shortly be doomed. Recent experiments made by Lloyds of London showed that the signal TTT (— — —) has certain advantages over the old SOS (· · · — · · ·).

While the new signal has, as yet, not been adopted, the chances are that it may be in the near future.

# FREE!

## Choice of One or More of These Popular Short Wave Books

Here's money put right into your pocket—here's a saving you never gave a thought to. You get absolutely FREE any one or more of the regular 25c and 50c short wave books with a year's subscription to SHORT WAVE CRAFT, the Radio Experimenter's Magazine. A one year's subscription brings you one fifty cent book or two twenty-five cent books; a two-year subscription brings you two fifty cent books and any one twenty-five cent book. Decide NOW what books are most necessary to you—then send us your subscription by return mail. The books will be sent to you immediately.



THIS popular short-wave magazine interests the great army of "hams," broadcast listeners, and general radio students who are interested in experimental as well as scientific angles of short wave development and application. In each monthly issue appears the largest and most correct short-wave station call list, and important construction articles on receivers and transmitters, including "pictureized" diagrams easily understood by anyone. A big feature "originated" by SHORT WAVE CRAFT. You'll also find the latest news about short-wave physics, micro- and ultra-short waves and other applications of this newest branch of radio.

### Many Short Wave Sets to Build

Many excellent short-wave sets with complete construction details with "picture" diagrams, are found in every issue—these sets vary from simple one- and two-tube sets to those of more advanced design, five and eight tubes.

### Big Silver Trophy FREE!

Recently inaugurated by Mr. Hugo Gernsback, Editor, was the "Short Wave Scout Contest." To the Short-Wave "fan" who has logged and obtained verification of the largest number of short-wave stations from all over the world, during one month, will be awarded a magnificent silver Short Wave Scout Trophy.

4-Color Cover 9" x 12"—  
Over 200 Illustrations

**25¢ The Copy**



On All  
Newsstands

SHORT WAVE CRAFT, Dept. RC-734  
99 Hudson St., New York, N. Y.

Gentlemen: Enclosed you will find my remittance for a subscription to SHORT WAVE CRAFT for

One Year @ \$2.50 (Canadian and foreign \$3.00)

Two Years @ \$5.00 (Canadian and foreign \$6.00)

Send me FREE books which are circled below.

1      2      3      4

Name .....

Address .....

City ..... State .....

(Send remittance in check or money order. Register letter if it contains cash or unused U. S. Postage Stamps.)

## MAIL COUPON TODAY



# FREE RADIO MANUALS

With every order of ARCO TUBES for \$10.00, or multiple thereof, you can get one, two or three 1934 Official Radio Service Manuals absolutely FREE.  
If you prefer, you can have copies of the 1934 Official Short-Wave Radio Manual FREE with orders for \$5.00 or both Manuals for orders of \$17.00. Remember that the regular list price of the 1934 Official Radio Service Manual is \$3.50, and the 1934 Short-Wave Manual, \$2.50. This offer is subject to withdrawal without notice.

Type No.	Your Cost	Type No.	Your Cost	Type No.	Your Cost	Type No.	Your Cost
00A	\$0.40	42	.60	81	1.10	6E7	.85
01A	.30	43	.85	82	.85	6F7	.85
1	.85	44	.60	83	.85	6Y5	.85
10	1.10	45	.40	84	.85	6Z3	.85
12A	.40	46	.60	85	.60	6Z4	.85
20	.40	47	.60	89	.60	6Z5	.85
22	.85	48	1.10	X199	.40	12A5	.85
24A	.40	49	.85	V199	.40	12Z5	.85
26	.30	50	1.10	2A3	1.10	25Z5	.85
27	.30	51	.60	2A5	.85	12Z3	.85
30	.60	53	.85	2A6	.85	18Z3	.85
31	.60	55	.60	2A7	1.10	185	.85
32	.60	56	.60	2B6	1.10	401	1.50
33	.85	57	.60	2B7	1.10	403	2.00
34	.85	58	.60	5Z3	.85	484	.85
35	.60	59	.60	6A4	1.10	485	.85
36	.60	71A	.30	6A7	1.10	586	2.10
37	.60	75	.85	6B7	1.10	686	.85
38	.60	77	.85	6C6	.85	866	2.75
39	.60	78	.85	6C7	.85	PZ11	.85
40	.40	79	1.10	6D6	.85	W1911	.60
41	.60	80	.40	6D7	.85	W1912	.60

Order from this advertisement—Remit 20% with order, balance C.O.D. All prices are F.O.B. FACTORY, Newark. Shipments go forward express or parcel post. No order for less than \$3.00 accepted. All tubes RCA licensed—6 month Guarantee.

**ARCO TUBE CO.** 232 Central Ave. NEWARK, N. J.

## 24 Years of LEADERSHIP

When you need Condensers, Chokes, Sockets, Shields, etc., for receiving or transmitting, or for replacement purposes, consult the Hammarlund Catalog, and benefit by the experience of pioneer radio designers.

Write for new FREE CATALOG "RC-7"

**HAMMARLUND MFG. CO.**  
424-438 West 33rd Street  
NEW YORK CITY

For Better Radio  
**Hammarlund**  
PRECISION  
PRODUCTS

## WANTED!

Jobbers—Mail Order Houses and Representatives in all Territories

### TWO FAST MOVERS



Free Edge Cone and Voice And—Field Coils for all Coil Assemblies Dynamic Speakers  
We also Manufacture Various Types of Magnetic Speakers

We can Supply and Remedy Your Speaker Needs. Speaker Mfrs. Since 1921

**LEOTONE RADIO CO.,** 63 Dey St., New York, N.Y.



**SOLAR**

WET AND DRY ELECTROLYTIC PAPER AND MICA CONDENSERS

RECOGNIZED FOR SUPERIOR QUALITY IN ALL CLIMATES THE WORLD OVER

SOLD BY LEADING JOBBERS EVERYWHERE

**SOLAR MFG. CORP.**  
599 BROADWAY  
NEW YORK

**BEST BY TEST!**

ASK FOR CATALOG OF EXTREMELY COMPACT TYPES HANDY FOR SERVICE

**Telechime**  
ELECTRIC CHIMING CALL SYSTEMS

Amplify Telechime—a real opportunity. Write for our special offer to radio men.  
**General Komprolar Co., Inc.**  
**DAYTON, OHIO.**

## SHORT CUTS

(Continued from page 31)

We now have three dimensions, namely, A, B and C. We now divide circle B into 12 equal sections, P, all of which terminate at the center. With circles B and C drawn, project 4 lines by means of a T-square. Now 2 vertical lines are drawn to intersect the 4 projected lines. (The distance that separates these 2 lines is decided by dimension A; the length of the vertical lines, by the 4 lines projected from circles B and C.) Connect the 4 extremes together to form the side view of the cone, X1, X2. Your drawing should now resemble the illustration.

Placing the point of the compass at point A and the pencil of the compass at X1, scribe a circle. Repeat the process at X2, drawing the smaller circle inside the larger one. A circle about 1/8 to 1/4 in. smaller, inside of circle C1, decides the size of the radial cuts, etc.

Now with the dividers take dimension P and mark off 12 spaces on the circumference of circle B1. You will now have 13 lines terminating at a central point from the circumference. A flange is drawn on one side of the line as shown in the drawing, which is used in pasting the cone together.

After the form is cut out and the radial cuts made the cone is ready for gluing.

The list of materials is: One compass, one pair of dividers, a suitable piece of drawing paper or wrapping paper and a T-square.

## AN EMERGENCY TUBE SOCKET

B. O. Bass

**S**ERVICE Men and experimenters do not always have time to order sockets, for emergency jobs in modernizing sets, adapting microphones, photograph pickups, short-wave converters, twin-speaker plugs, and multi-wire cable connectors.

For additional test-kit socket and adapter plug requirements the socket shown in Fig. 4 has no equal.

Break off the prongs of an old tube base. (This is preferably of the same type as the socket to be constructed—although, any old base may be used by drilling holes to correspond to the new tube prongs, using a template made by accurately punching holes, through a celluloid or mica strip, with the new tube.)

Saw off the top of the old base so that the resulting socket will be slightly higher than the prongs of the new tube. Invert the tube base and drill out each prong hole with a drill corresponding in size to each successive prong. Countersink each hole with a 1/4-in. drill so that the tube prongs, when bent slightly off-center, will center automatically and thus form a good tension contact to the prongs.

Saw two parallel notches with a hack saw, in top and base of the socket at each hole, as shown in Fig. 4, and enlarge with a thin, flat file or larger saw. Saw the slots 1/8-in. deep and 5/16-in. apart. Cut off the latch of some 2 in. safety-pins, fit the eyelet over a tube prong, insert the tube in the socket, and bend the pin legs tightly into the notches.

Apply a coat of speaker cement to the sides of the socket and wrap with an alternate layer of rubber tape and stiff paper tape.

For sub-base mounting let one of the safety-pin legs stick down through the sub-panel (clipping off the other leg on each contact spring). Bend a 1/16-in. foot on it, and hold it in place in the hole with a wooden peg.

For a spring suspension socket bend both legs of each contact spring at right angles and bolt down to the insulation.

## A CONDENSER-MIKE HEAD-AMPLIFIER ADAPTER

Erick A. Leander

**T**HE condenser-mike head amplifier shown in Fig. 5 is A.C. operated, using the filament and plate current from a main amplifier. Compared with an old-style head amplifier using two type 30 tubes operated on batteries, it has been found to be much superior. The first requirement is a main amplifier that is hum-free. Take the filament current



ANNOUNCING

A New  
**TRIPLETT**  
All-Wave  
**OSCILLATOR**

NO.  
1181



**T**RIPPLETT engineers developed the ALL-WAVE Oscillator, in answer to the growing demand from service men for a well-designed, completely shielded all-wave signal generator. This new Triplet instrument is advanced in design, precision built, compactly constructed, and absolutely dependable. It gives a signal output of constant level... either modulated or unmodulated.

The charts are hand calibrated and cover a frequency range of 110 to 14,000 KC. The frequency ranges are controlled by a 4-position band change switch. The condenser shaft is at ground potential. This means that there is no radiation of signal from condenser shaft or screws. A perfected attenuator control makes it possible to use the signal generator on the most sensitive as well as the weakest receivers. It is desirable for stage-by-stage elimination by the oscillator method.

No. 1151 is a single All-Wave Oscillator. Dealer's net price.....\$23.34

No. 1180 is made up of the combined All-Wave Oscillator and Volt-Ohm-Milliammeter. Dealer's net price..... 30.00

No. 1181 is a combination of Volt-Ohm-Milliammeter, Free-Point Tester, and All-Wave Oscillator. Dealer's net price..... 38.00

Your Jobber Can Supply You

## The Triplet Electrical Instrument Co.

67 Main Street Bluffton, Ohio

Mail Today for Details!

THE TRIPPLETT ELECTRICAL INSTRUMENT CO.  
67 Main St., Bluffton, Ohio.

Gentlemen:  
Send me catalog on Triplet ALL-WAVE Oscillator, and your complete line of radio servicing instruments.

Name .....

Address .....

City..... State.....





### Servicemen! Reduce the High Cost of Keeping Up-to-Date

Here in one inexpensive 28-lesson course—the only one prepared exclusively for active servicemen—Sprayberry gives ALL the dope on modern radio servicing. Covers every detail including Testing, Repairing (AVC, all wave, short wave, auto radio, P.A., etc.); Parts Testing and Trouble Shooting—also tubes, modernizing set analyzers and selling. No "fluff," mathematics or fancy bindings—a practical, how-to-do-it course that will save hours of reading in scattered sources. Moderate cost—\$10 for course only or \$15 with personal instruction and answers to questions by Mr. Sprayberry himself. Money back guarantee. Write for FREE details!

**F.L. SPRAYBERRY** 132 Bryant St., N.W.  
Washington, D. C.  
Please rush complete details of your new 28-lesson course, "PRACTICAL MECHANICS OF RADIO SERVICE." These, of course, are free.

Name .....  
Address .....  
City ..... State ..... C-7/4

### Now Should <sup>you</sup> Have This

**192 PAGES** **SHORT WAVE**  
**MANUAL** **PUBLIC ADDRESS**



Bound in a Beautiful  
Red Leatherette Cover

Size 5 1/2 x 8 1/2 inches  
**SPECIAL FEATURES**

- \*S.W. Receiver Construction Articles
- \*Public Address Construction Articles
- \*Transmitting Articles
- \*Efficient Aerial Installations
- \*Characteristics of Tubes
- \*Testing Equipment

Only  
**50¢**

And Many Other  
Important Items

Reserve Your Copy Now. Every Radio Man Will Find This Book a Veritable Book of Data Dealing with All Kinds of Radio Problems.

**TRY-MO RADIO COMPANY, Inc.**  
85-C Cortlandt Street, New York, N. Y.  
Send for a FREE Copy of Our P.A. Circular

## The demand is increasing for WARD LEONARD RESISTORS



Progressive jobbers are  
supplying this demand

SERVICE MEN KNOW Ward Leonard resistors are dependable. The price is so low there is no profit in taking chances with overrated resistors. Ward Leonard resistors are wire wound with silver soldered joints at the terminals. The resistance does not change. They assure quiet operation.

Write for NEW literature  
for service men.

**WARD LEONARD ELECTRIC CO.**  
MOUNT VERNON, N. Y.



### 110 VOLT AC POWER From AUTO GENERATORS

This unusual book, complete with drawings and illustrations, tells you how to easily change Ford, Chevrolet, or Dodge generators, and produce 32 to 110 volts. AC or DC. Gives power for radio testing, shop tool operation, floodlights, etc. Price only \$1.

**AUTOPWER, Dept. L, 410 S. Hoyne Ave., Chicago**

from the heater-type tube windings, not from the same winding that supplies the power tube.

In the writer's method of connecting the head and main amplifiers, one side of the transmission runs direct from the plate of the 56 tube shown at C, to the coupling condenser in the main amplifier, as shown at D. This system not only does away with coupling transformers for lines up to 100 ft., but also eliminates the tendency of these units to pick up hum frequencies.

Be sure to keep the A, C, wires away from the grid of the 56 tube in the head amplifier. Also, keep the wire from the diaphragm to the coupling condenser in the head amplifier as short as possible to prevent excessive loss of signal.

The impedance shown in C may be any available high-impedance secondary.

The inside frame of the mike box is made of heavy steel, with a hole cut in it for the type 56 tube socket; the transformer is also mounted on this frame, one part of which forms a shielding partition, B, between the tube and the condenser head.

## REMOTE CONTROL

(Continued from page 25)

arrangement of component parts for a pentagrid converter type tube which acts as a combined first-detector and electronic-coupled oscillator. The signal is fed into the antenna coil via a lead centered in a large-diameter, grounded shielding "loom," thus avoiding loss of signal strength due to capacity between the antenna wire and the grounded shield. The antenna coil is of the high-gain type with a small capacity coupling to boost the response at the higher frequencies. The primary resonates at a frequency below the broadcast band so that the lower radio frequencies are amplified equally. The screen-grid potential is obtained through a series resistor. The output transformer consists of a primary, tuned to 456 kc., coupled to a low-impedance secondary consisting of 2 turns. An input transformer similar to this is required in the remote speaker-amplifier unit, but here the primary consists of 2 turns and the secondary is tuned to 456 kc. The reason for the low-impedance line is to avoid loss of the I.F. signal in the transmission cable connecting the two units.

In order to eliminate reception of signals at the I.F. level and to avoid ignition noises, it is advisable to make up the cable of individually shielded wires as follows: (1) a single wire shielded, for the I.F. line; (2) a double wire, shielded, for the volume control circuit, and; (3) a double heavy wire, shielded, to supply heater current. Since the I.F. line wire is by far the most important one to shield, it is usually satisfactory to use a single, grounded shield over the entire seven wires. Be sure to use heavy wires for the heater circuit since small wires will introduce enough resistance to rob the tube filaments and "B" power unit of the full "A" battery voltage.

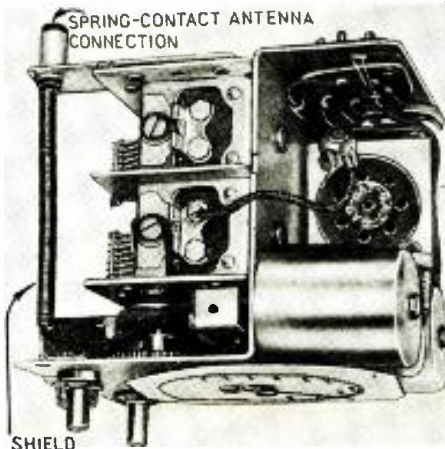

SHIELD

The interior of the tuning unit; 6A7 tube plugs into the socket at the right.

## 10¢ A DAY BUYS A NEW REMINGTON PORTABLE TYPEWRITER

Special 7-Day Free Trial Offer

Think of it! You can buy a new standard Remington Portable Typewriter for but 10c a day. Standard keyboard. Small and capital letters. Beautiful finish. Carrying case included free. Exceptional money-making opportunities. Write today. Say: Please tell me how I can get a new Remington Portable typewriter on your special 7-day free trial offer for but 10c a day. Remington Rand Inc., Dept. RC-12, Buffalo, N. Y.



## Many POPULAR EXPERIMENTS in Every Issue!

Over 150  
Illustrations  
25c the Copy  
On All Newsstands

EVERYDAY SCIENCE AND MECHANICS is the finest scientific-technical-mechanical-constructional magazine in the field. Up-to-the-minute with news flashes of scientific events. Dozens of constructional articles and many popular experiments. Ideas from which you can make things to sell.

A HOST OF INTERESTING SUBJECTS COVERED:—Aviation—Woodworking—Astronomy—Patents and Inventions—Book Reviews—Metalworking—Chemistry—Engineering—Microscopy—Electrical Experiments—Lathes Operation—Shop Hints and other subjects.

**SPECIAL OFFER—\$2.00 FOR ONE YEAR—**  
(Canadian and Foreign \$2.50).

Send Check or Money Order.  
**EVERYDAY SCIENCE AND MECHANICS**  
99R Hudson Street New York, N. Y.



## 10 HOURS of Reading Pleasure

Six Stirring Stories of

### Future Science in Current Issue

WONDER STORIES brings to its readers vivid, thrilling, and absorbing tales of adventure on alien planets—stories of biological monstrosities, time-travel, the future civilizations of man, and other educational science-fiction themes.

Here is the contents for July: ENSLAVED BRAINS by Eando Blunder. VOICE OF ATLANTIS by Laurence Manning. A MARTIAN ODYSSEY by Stanley G. Weinbaum. A HAIR-RAISING TALE by W. L. Sheppard, Jr. THE LAST SHIP by Chester D. Outbiter, and DRUSO, the tremendous German novel by Friedrich Freksa—plus several interesting departments. The voice of the SCIENCE FICTION LEAGUE.

**SPECIAL OFFER (in U.S.A. only)—One year for \$2.00.**  
Send check or money order.

**WONDER STORIES, 99-R Hudson St., New York, N. Y.**

## SEXOLOGY

THE MAGAZINE OF SEX SCIENCE

SEXOLOGY, foremost educational sex magazine, is written in simple language and can be read by every member of the family. It is instructive, enlightening—not a risqué book—contains no offensive matter.

Contains 25 important articles on Sex Science, 68 pages, with attractive two-color cover. Here are a few of the more important articles:

Editorial—"Sex Inventions"; Popular Mistakes About Sex (illustrated); Males Made to Give Milk; "Blue Babies" (illustrated); Posture and Menstrual Pain (illustrated); Is Frigidity Curable?; Mechanics of Male Anatomy (illustrated); Sex Mystery of Queen Elizabeth (illustrated); Sex Impulses of the Young (illustrated); Menstrual Poison (illustrated); Infantile Sex Organs; Sex Life of the Criminal.

Get a copy of SEXOLOGY on any newsstand, or if your dealer cannot supply you, send 25c in stamps for a copy of the current issue.

SEXOLOGY, 171R Franklin St., New York, N. Y.



The volume control furnished is a 1/2-meg. tapered unit intended to be used in the A.F. grid circuit. The "B+" lead connects to the highest positive potential in the speaker-amplifier unit. Fair results can be had on as low as 90 V. All coils are individually shielded. The tube has a rubber cushion to eliminate road shock.

#### Aligning the Circuits

To adjust the trimmer condensers in the tuner, the usual procedure is followed. First align the I.F. primary trimmer (which is located just behind the dial face) to 456 kc. Then tune in a signal near the high-frequency end of the dial. Having the dial pointer set to the correct frequency, adjust for maximum volume the 2 trimmers through holes on either side of the steering column bracket. Finally, tune in a signal at the low-frequency end of the dial and adjust the padding condenser, C1, with an insulated screwdriver; this condenser may be reached through a hole in the back of the tuner. The tube can be removed for testing by first removing the metal cap that fits into the moulded metal case, and then carefully pry the tube base from the socket by means of a screw driver. Do not attempt to pull the tube out of its socket by grasping the control-grid cap. The cable plugs into a male chassis socket in the rear. The antenna bayonets into its receptacle, firm contact being maintained by means of a spring. The ratio between the knob and condenser shaft is 4 to 1; the pointer turns through 270 deg. for 180 deg. of the condenser. The tuner is finished in a smooth black to match the average auto interior.

By the use of the new dual-service tubes, it is quite possible to obtain good local reception using this tuner and only two tubes in the remote speaker-amplifier unit. (The builder can use his own ideas as to the details of the remote set and power supply.)

## AUTO-RADIO INSTALLATION AND SERVICE HINTS

(Continued from page 25)

wound R.F. choke consisting of 75 T. of No. 18 "d-01" wire, on a form 2 in. in dia. connected in series with the "hot" lead from the set, and two 4 mf. condensers connected before and after the choke and to ground, will many times eliminate this difficulty. For more specific information on this "filter" see the schematic diagram of the Audioton receiver on page 27.

Concerning new devices and kinks which will make the work of auto-radio installation men easier, a glance at some of the photographs and illustrations on these pages will show some very interesting items that will prove a great boon to them.

#### An Auto-Radio Service Shop and Test Cage

In Figs. A and B are seen elements that contribute largely to a modern equipped service and installation shop, for servicing and installing auto-radio receivers *exclusively*. A specially constructed, screened cage is shown at B, for testing reception in a car without undue influences from the outside to hinder adjustments or proper installation. Because of the elimination of external noises or interference, it is possible to complete an installation in considerably less time, since absolute concentration on the noise that is caused by the engine only, results when the installation and service are performed in such a cage. The idea is an excellent one and is indicative of the ingenuity of the Service Man in his constant research for equipment or ideas toward improving his standard of work, which may prove to be labor saving.

#### Auto-Radio Rod Antenna

In Fig. C is illustrated a novel type of car antenna which should prove a great improvement over most ordinary types. It is a telescoping radio rod mounted outside of the car as shown in this illustration. When on the open road the length of this antenna may be extended, which will improve the "pick-up" efficiency tremendously. When driving within city limits, the antenna is reduced or adjusted accordingly. Naturally the efficiency

# HEADQUARTERS FOR PUBLIC ADDRESS AMPLIFIERS

BUY DIRECT from MANUFACTURER and SAVE BIG MONEY!



Here Are Our Most Recent Portable Public Address Amplifier Developments:

## Self-Contained Electric Phonograph "MIKE-PHONO-RADIO" COMPLETE PORTABLE P. A. SYSTEMS

Available in Choice of Three Basic Models:  
 110-VOLT A.C. 7 1/2 WATT 2 STAGE 2A5 CLASS "A" MODEL—110 VOLT A.C. 12 WATT 3 STAGE 2A3 CLASS "A" MODEL—6 VOLT STORAGE BATTERY OPERATED 13 WATT 3 STAGE 79 CLASS "B" MODEL—WHICH MAY BE OPERATED AT WILL FROM BOTH 6 VOLTS D.C. AND 110 VOLTS A.C.!

All models are equipped with a self-contained "INPUT-MIXER-FADER" CONTROL SYSTEM. Completely housed in a compact (15 3/4 x 14 1/4 x 13 1/8") two section (removable speaker) wood framed, fibre lined case.

Write for our unbelievable low price on this equipment!

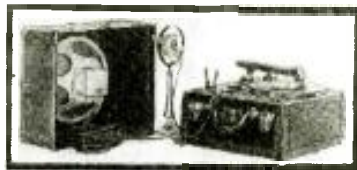

## JUST-OFF-THE-PRESS!



## SEND FOR THIS FREE Radio and Amplifier CATALOG

Entirely New From Cover to Cover  
 WE ARE HEAD-QUARTERS FOR P. A. SYSTEMS. Buy direct from the manufacturer and Pay Only One Profit!

100 PAGES OF RADIO VALUES!

## OFFICIAL PUBLIC ADDRESS AMPLIFIER MANUAL AND SOUND SYSTEM TREATISE

THE ONLY BOOK AVAILABLE OF ITS KIND!



Devoted Exclusively to the Problems Involved in Purchasing, Designing, Measuring, Testing, Installing, Operating, Troubleshooting, Maintaining, and Money Making Possibilities of Public Address Systems.

AVAILABLE WITH VALUABLE SUPPLEMENT SERVICE

LOOSE LEAF contains 100 64 Pages, 8x10% OVER 150 DIAGRAMS CHARTS and ILLUSTRATIONS

WRITTEN IN PLAIN CLEARLY UNDERSTANDABLE LANGUAGE

A Vital Necessity to Everyone Connected in Any Way With Sound-Systems—Public Address Work—or Amplifiers and Associated Equipment! Complete and Authoritative!



COAST-TO-COAST-RADIO-CORP.  
 123 K-WEST 17TH STREET, NEW YORK, N.Y.



# WEBSTER—Chicago Public Address Systems



## NEW Three-Stage 10-Watt Microphone and Phonograph Amplifier

Provides Microphone Current  
 Has Dual Control  
 Is Completely Enclosed

## WEBSTER—Chicago B54 Amplifier

A Powerful Public Address System  
 Reasonably Priced to Meet Competition.  
 Quality for Performance. Send for Circular.

## THE WEBSTER COMPANY

3830 West Lake Street

Chicago, Illinois



# Enjoy Your Trips WITH POSTAL Auto Radio

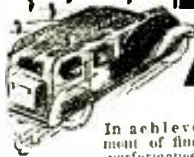

In achievement of finer performance, more rugged construction and improved design, the Postal Auto-Radio of six tubes has many superb features still to be found in other models. Travel this season will be more enjoyable with the Postal Auto-Radio.



This fine receiver is powered by six tubes: 2-78's, 1-75, 1-41, 1-6A7 and 1-84, and has built-in dynamic speaker. It has remote control unit with aviation dial to make tuning easier. AVC and 20 other features. Write for complete literature . . . and FREE attractive brochure covering essentials of auto-radio servicing. . . . Mail Coupon.

## POSTAL RADIO 135-K LIBERTY ST. NEW YORK, N.Y.

Please send me FREE brochure of auto-radio servicing notes and full information about the POSTAL 6-Tube AUTO-RADIO.

Name .....

Address .....

City .....

SELECTION · PRICE · SERVICE

RADIO SUPPLIES

GET OUR BIG CATALOG

**RADOLEK CO., 139 Canal Station, Chicago**

I am a Dealer ; Serviceman   
 I operate from Shop or Store ; Home   
 I own the following Test Equipment.....  
 My training and experience is .....

Name .....

Address .....

City .....

**RADOLEK · CHICAGO**

### WORLD WIDE ALL WAVE RADIO

A real, powerful long and SHORT WAVE Radio Receiver that actually gets local and foreign broadcasts, police, amateur, airplane, etc., transmissions direct! Thousands now in use. Owners report reception of Foreign Stations with amazing volume.

Works on two inexpensive batteries. Not a toy! Results Guaranteed! See construction kits have all necessary parts mounted on attractive metal chassis, all ready for wiring. Clear picture diagrams. Wire it yourself. It's easy. Only six connections and the set is ready to operate. Wave-length range 15 to 600 meters. Complete Kits, with coil—

• One Tube Kit, \$1.95 • Two Tubes, \$2.85  
 (Wired and tested for 75c extra)

Tube—Special type for use on ONE dry cell... 85c  
 Phones—Double Headset ..... \$1.25

Order Now! Send \$1. balance C.O.D., or if full remittance we pay postage.

LOOK! Large, three color MAP of the WORLD, Time Chart, S. W. Sta. List, Description of above and other receivers. Send 25c NOW!

Dealers! Cash in on this S.W. Sensation! Write for quantity prices.

**ACE RADIO LABS., Dept. R-7, 1619 Broadway, N.Y.C.**

\$1.95

**BACK ISSUES OF RADIO-CRAFT**

which you might need to complete your files, can still be had at the price of 25c per copy. Send us your requirements, together with your remittance in check or money order.

**RADIO-CRAFT, 99 Hudson St., New York City**

of the antenna is not as great, under this condition, but large antennas are not essential where local stations are plentiful. The essential feature of this type of antenna is that the efficient portion of the rod length which "picks up" most energy is beyond the field of interference radiations, and consequently less noise interference is obtained. For short-wave transmission purposes (mobile transmitters) this type has interesting possibilities since, for short waves, it should be a splendid vertical antenna of the half- or quarter-wave type.

### Set "A" Drain Automatic Compensator

In Fig. D is shown a unique device for automatically increasing the charging rate from the car generator to the storage battery. It would be needless to mention that the additional drain imposed on the car battery by a radio receiver should be compensated for by a higher charging rate. If it were not for the fact that so many installation men neglect to take care of this point when completing an installation, this device is completely shielded so that it will not in any way contribute to the interference that is normally radiated by the ignition system. Its operation is such that when the receiver is turned "on" a relay in its container automatically increases the charging rate by approximately 5 A. This is accomplished electrically, without any necessity for third-brush adjustment or regulation of the generator. The car ammeter will always read "normal" when this device is installed, inasmuch as it compensates for the drain when the set is turned "on."

### Auto-Radio Shielded R.F. Transmission Line

Most antennas that employ a shielded lead-in to the receiver are not as efficient as they might be, due to the additional capacity that is created between the wire and metal sheathing running the length of the wire. This capacity, which is of a high value, in the case of long lead-ins, can be considered as being in shunt with the antenna coil primary, which creates a resonant circuit at which the receiver is most efficient (and is otherwise inefficient), and bypasses a considerable amount of R.F. energy to ground, besides introducing other detrimental features which tend to diminish the over-all efficiency of the set. Most installation men, recognizing these facts, ignore grounding the shielding of the lead-in, which minimizes its effect as a shielding against ignition disturbances. In Fig. E is a complete, shielded-type antenna lead-in kit which overcomes all of the aforementioned difficulties. A matching-transformer or coupler is employed to compensate for the high effective capacity existing between the lead-in wire and shielding; at the same time it permits the shielding to be grounded without introducing any loss in the transfer of antenna energy to the receiver.

### Improved Types of Noise-Suppressors

In Fig. F is a complete set of noise suppressors of various types. (The resistor element is embedded in a ceramic having a low coefficient of expansion.) It is a well known fact that to reduce the effect of spark plug discharges on reception, the suppressor must be installed as close to the plugs and distributor as is possible. The suppressor shown in C of Fig. F is adaptable to most car engines, but occasionally a car is received where it is impossible to secure the suppressor to the plug. Valve-in-head engines, or recessed cylinder heads where the plugs are inaccessible except with a special plug wrench, or completely enclosed distributor heads—are all instances where special types of suppressors are helpful. Suppressors A and B in Fig. F are of the "splice-in" type and will be found to fit in most of the extraordinary installations that may turn up.

When installing suppressors, always be sure that they are of "proven" types, since ordinary suppressors will almost always give trouble, in time, due to resistance changes caused by an increase in temperature. A good many installation men hesitate to employ ordinary suppressors with a high resistance value since, by experience, they have learned that there is consequent reduction in motor efficiency. In Fig. G is shown a type of suppressor which is becoming more

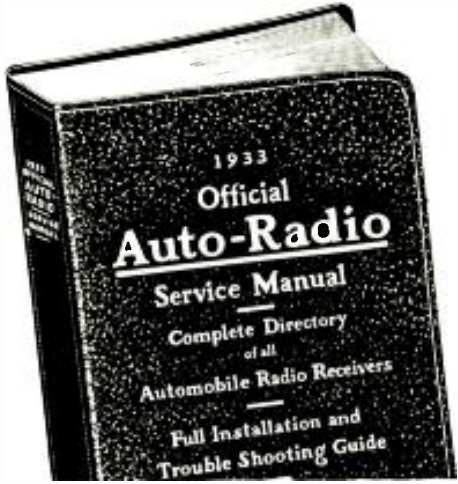

# FREE

## 48-Page Supplement to the Auto-Radio Service Manual!

To everyone who now purchases the OFFICIAL AUTO-RADIO SERVICE MANUAL, this big 48-page Supplement is issued FREE. Practically all of the latest sets, together with servicing information will be found in these new pages. The new Supplement does not increase the cost of the book to you, but gives you an Auto-Radio Service Manual that is right up-to-the-minute with service notes.

**Good Money in Servicing Auto-Radios**

If you are overlooking servicing auto radios, you're missing a great deal of business. The auto-radio business had its greatest boom last summer when thousands of sets were sold. By now many of these same sets require servicing and with hundreds of them right in your own community, you can build up a good auto-radio servicing business. In a short time you can easily add 25% or more to your regular servicing business.

**List of Sets Covered in the Manual**

Acme Radio Mfg. Co.	P. H. Mallory & Co.
Allied Radio Corp.	Mellhorn Radio Mfg. Co.
Atwater Kent Mfg. Co.	Montgomery Ward & Co.
Audion Radio Co.	National Co., Inc.
Autocrat Radio Company	Nobilit-Sparks Ind., Inc.
Automatic Radio Mfg. Co.	Phileo Radio & Tel. Corp.
Carter Genemotor Corp.	Pierce-Alro, Inc.
Century Radio Prods. Co.	Premier Electric Co.
Chevrolet Motor Company	Radio Chassis, Inc.
Consolidated Industries, Ltd.	RCA-Victor Co., Inc.
Crosley Radio Corp.	Sentinel Radio Corp.
Delco Appliances Corp.	Sparks-Whittington Corp.
Detrola Radio Corp.	Stewart Radio & Tel. Corp.
Emerson Electric Mfg. Co.	Stowart-Warner Corp.
Fada Radio & Elec. Corp.	Stromberg-Carlson Tel. Mfg. Co.
Federated Purchaser, Inc.	Transformer Corp. of Am.
Ford-Majestic	United Amer. Bosch Corp.
Franklin Radio Corp.	United Motors Service
Galvin Mfg. Corp.	U. S. Radio & Tel. Corp.
General Electric Co.	Utah Radio Prods. Co.
General Motors Corp.	Wells-Gardner Company
A. H. Grebe & Co.	Wholesale Radio Serv. Co.
Grigsby-Grunow Co.	Rudolph Wuritzer Mfg. Co.
Chas. Hoodwin Company	Zenith Radio Corp.
International Radio Corp.	

\$2.50

Over 200 Pages  
Over 500 Illustrations  
9 x 12 Inches  
Flexible, Loose-Leaf Cover

Mail This Coupon Today!

GERNSHACK PUBLICATIONS, Inc. RC-731  
99 Hudson Street, New York, N. Y.

Enclosed you will find my remittance of \$2.50 for which please send me One Copy of the 1933 OFFICIAL AUTO-RADIO SERVICE MANUAL with FREE 48-page Supplement. Send remittance in check or money order. Register letter if it contains cash or currency. WE PAY POSTAGE.

Name .....

Address .....

City .....



and more popular as the season progresses. Instead of employing a pure resistance in its construction, an R.F. choke whose inductance value is high but D.C. resistance is low, is used. Thus all the R.F. energy (from the spark plug discharges) that causes "static" noises in the car radio set is kept within the plug. The low D.C. resistance minimizes the voltage drop across the suppressor.

#### Novel Car-Radio Antenna

A novel device incorporating some of the principles involved in the operation of the device shown in Fig. E, is the antenna shown in Fig. H. A wire that is sewed within the cloth, as shown by the dotted line, has another wire helically wound around it and covering the full length up to each free end. The helical winding then becomes a step-up transformer boosting received signals, while the inner wire which is grounded at both ends aids toward eliminating noise interference by virtue of the capacity effect created between the internal conductor and the helical winding, states the manufacturer; he further claims that this antenna may be located anywhere convenient within the car, either under front or rear seat (preferably the latter, so that it is as remote from the engine compartment as possible) and that it will work well in any car.

#### Modernizing Old Auto-Radio Sets

A great many auto receivers that were installed a few years ago are probably functioning to the satisfaction of their respective owners, with possibly one exception. That exception is probably, in most cases, the constant necessity and expense of replacing "B" batteries. This generally involves an expenditure of about \$10.00 (for good "B" batteries, where 3 or 4 45 V. blocks are required) approximately four times a year, if the set is constantly used. And not only that, but the subsequent reduction of sensitivity or over-all efficiency as the batteries commence to weaken is oftentimes the cause of many disappointments when reception "on the road" is desired.

Naturally, the most effective cure for this sort of nuisance would be the installation of a "B" eliminator unit which would operate from the 6 V. car battery. One which can be easily built (parts obtainable in kit form) is shown in Fig. 1, with the schematic wiring diagram in Fig. 1. This particular unit has that most essential feature of flexibility, in that it may be used with any type of auto-radio receiver. This is due to a tapped voltage output arrangement which enables its use with receivers that require intermediate voltages ranging from 90 to 250 volts.

### BOOK REVIEW

**ELEMENTS OF RADIO COMMUNICATION**, (Second Edition), by John H. Morecroft. Published by John Wiley & Sons, Inc. Size 6 x 9½ ins., 286 pages, 241 illustrations, cloth covers. Price, \$3.00.

In the January, 1930 issue of **RADIO-CRAFT** we reviewed the First Edition of this volume; it is with pleasure that we present a short review of the modernized, Second Edition of **ELEMENTS OF RADIO COMMUNICATION**, by Dr. Morecroft.

A general idea of the manner in which the contents is arranged may be obtained by reference to the chapter headings, as follows: I, Simple Laws of Electric Circuits; II, Special Laws for Radio Circuits; III, General Idea of Radio Communication; IV, The Vacuum Tube and Its Uses; V, Radio Telegraphy; VI, Radio Telephony; Receiving Sets; Problems; Index.

Use "ELEMENTS" as an everyday reference to formulas and general practice; use Dr. Morecroft's "PRINCIPLES," the radio technicians "Bible," for the more complicated problems.

The open-minded and modern spirit in which the Second Edition of "ELEMENTS" has been compiled is exemplified in the lines which we quote from the article on multi-element tubes, as follows:

(Continued on page 61)

Subscribe to this Publication!  
only 50¢ per year—12 issues



### SERVICEMEN AND SET BUILDERS Can't Afford To Miss A Single Issue

This monthly technical periodical, published by Aerovox, for radio servicemen, experimenters, technicians, and engineers, gives first hand, authoritative information on the latest developments in radio and the proper uses of condensers and resistors in various circuits. Articles appearing regularly in each issue contain non-commercial information on subjects covering many of the important problems met with in everyday radio practice, that are not to be found in any other publication of its kind.

Send for a FREE Sample Copy or Mail This Coupon with 50c for a One Year Subscription.

AEROVOX CORPORATION RC-734  
76 Washington St., Brooklyn, N. Y., U.S.A.

Gentlemen:  
 Kindly place my name on the Research Worker mailing list for one year beginning with the next issue for which I am enclosing \$.....  
 50c per year in U.S.A. 60c per year in Canada.  
 Send me a FREE sample of the RESEARCH WORKER.  
 Send me the Aerovox 1934 Catalog.

Name .....  
(Please print)

Address..... City..... State.....

Kindly check classification of your connection in  
 Radio, Manufacturer  Engineer  Dealer   
 Jobber  Serviceman  Amateur or Experimenter   
 Student  Broadcast Station  Research Lab.

The World's Largest and Leading Manufacturer of Condensers and Resistors for Every Radio Requirement.

Electrolytic Condensers Adjust. Vitreous Resistors  
 Paper Wound Condensers Vitreous Enam. Resistors  
 Replacement Condensers Transmuting Resistors  
 Interference Filters Carbon Resistors  
 Mica Condensers Wire Wound Resistors  
 Transmuting Condensers Metalohm Grid Leak  
 Write for the latest 1934 Catalog of Aerovox Products



76 Washington St. Brooklyn, N. Y.



# AMPLIFIERS

for the

## POLITICAL CAMPAIGNS

... and complete public address systems—anything they want—to operate from car battery, from standard power line, or from both—for street ballyho, and to amplify speeches at gatherings.

That sound equipment plays a tremendously important part in modern political campaigning is a **PROVEN FACT**. No candidate for political office can overlook it. Take advantage of this market and write to the factory or your nearest U.S.E. Distributor for special literature.

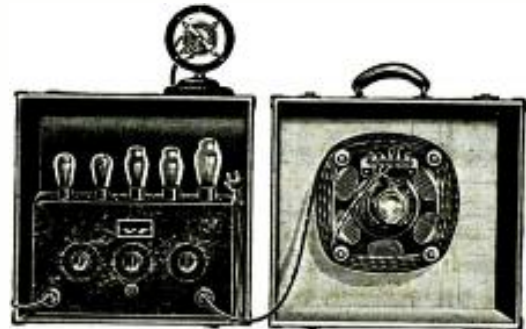

**UNITED SOUND ENGINEERING COMPANY**  
Manufacturers of Specialized Sound Equipment

2233 UNIVERSITY AVENUE

SAINT PAUL, MINN.

**VAN** offers genuine  
**SILVER-ETCHED METAL DIALS**

For Models 88 and 301  
Type Nos. 1, 2 and 4 for each model

### SHUNTS

27mv. - 30mv. - 35mv. - 50mv.  
ORDER THROUGH DEALER OR DISTRIBUTOR  
Descriptive Folder on Request

**D. L. VAN LEUVEN**  
410 East 15th St. New York, N. Y.

**Curtis**  
Electrolytic  
**CONDENSERS**

LOOK GOOD—ARE GOOD

Any Style, Size or Shape  
**CURTIS CONDENSER CORP.**  
3601 West 140th St. CLEVELAND, O.

# WELLWORTH WORTHWHILE

# BARGAINS!

**SERVICE MEN!** A BARGAIN SALE OF STEWART-WARNER

"WRITE-IT-URSELF" NEON SIGNS



This illustration is merely a single example of the limitless sales messages which may be written upon the "Write-it-Urself" Neon Sign.

You write your sales message on this glass as easily as writing on a blackboard.

When you want to change your message, you simply rub it off and write a new one. Your message stands out in brilliant, fiery-red—just as though you actually had written it with Neon tubing.

**HOW IT WORKS**

The "Write-it-Urself" is an upright gold lacquered window or counter Neon Sign, 25 inches wide, 20 inches high and 5 1/4 inches thick at the base. Within the framework are enclosed two plain glass panels, between which is a dark mat that causes the two glass surfaces to appear black when no lettering is upon them. Neon tubing completely encloses the glass (the tubing being inside the frame) and, when the blank glass is lettered the powerful, fiery red rays from the Neon tubing are reflected in the lettering—appearing exactly like a sign actually formed by bent glass Neon tubing.

**AS LONG AS SUPPLY LASTS** ..... **\$12.95**  
 (Original Price \$35.00) ..... each  
 Shipping Weight: 35 lbs.

**COMPLETE LETTERING KIT FURNISHED FREE**

Lettering any desired message on the sign is simplicity itself. With every "Write-it-Urself" Neon Sign, is furnished a complete lettering kit containing a lettering brush, one jar of Lettering Fluid, a Lettering Eraser, one can of special Erasing Fluid and a soft cleaning cloth. In addition, a complete 64-page book of instructions—containing simplified alphabets, typical "sign copy" examples for nearly every stable business, etc.—accompanies every sign.

Sold complete with lettering kit and 9-foot electric cord for plugging into any standard 110 - 120 - volt, 60-cycle A.C. light socket.

## KELLOGG Hand Microphone

GOLD-PLATED DIAPHRAGM



This single button microphone is used extensively for radio broadcasting, public address systems, call systems for factories, offices and hotels, amateur short wave transmitting, home recording and commercial recording work.

The Microphone is designed to operate into the usual 200 ohm input circuit. It requires a current of 3 volts and .010 to .015 amperes. The button has a resistance of 200 ohms.

The diaphragm is gold plated for perfect contact and permanent efficiency. It is protected from external injury by a strong fine-mesh steel screen.

The handle is made of cast aluminum, assuring lightness and durability. The microphone case is of drawn brass. The frame and stretching ring are drawn and machined from the finest grade of steel. The entire unit is finished in black nickel.

Each microphone is equipped with a two-conductor 18-strand tinsel cord that measures 6 feet from tip to tip. Shipping weight: 2 lbs.

**\$2.43** EACH

## ELECTRO-MAGNETIC CLOCKS

Imported from France

Here is a clock-movement which sold originally for \$35.00. As long as supply lasts, we offer it for as low as \$2.17.

This French clock-movement does not use any outside electric current, neither A.C. nor D.C. A small 1 1/2 V. flashlight battery imparts the impulses to the electro-magnetic motor contained in the movement, producing its own energy. The battery lasts for years as the total current consumption is only 1.2 watts for a whole year. There are no out-side wire connections; as soon as the flashlight battery is connected, the movement starts and runs for years without attention. The movement is absolutely noiseless. There is no winding, no lubrication, no care. It is very easily adjusted and like all French clock movements, absolutely accurate. Once the weight of the pendulum is adjusted when you set the clock, it will run with the same constancy and accuracy for years.

Build your own clock cabinet, or replace old fashioned clock movements with this fine clock work.

These imported French clock movements come in three sizes:

Outside diameter of 4, 5, and 6 inches.

The Dial is enclosed in a brass case, covered with a convex bevelled crystal, on a hinged frame.

Shipping weight: 5 lbs.

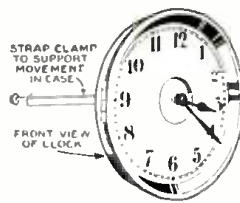

View of Front Showing Dial and Hands.

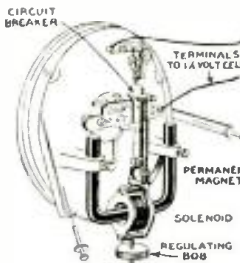

View of Movement and Electro-Magnet

- 4 in. (comes without brass dial-frame or glass cover)..... **\$2.17**
- 5 in. as described..... **\$2.46**
- 6 in. as described..... **\$2.89**

## G. E. PHONOGRAPH MOTOR

Variable speed induction type self-starting, 110 volt, 60 cycle, A.C. with lever control. Speed range from 5 to 200 R.P.M. Can be installed in place of old-fashioned, hand-winding speed motor. Also ideal for display turn table, and a hundred other uses. These G.E. Electric Motors are brand new, in original factory cartons. Same motor that formerly sold for \$15.00.

Shipping weight: 11 lbs. Dealers and Manufacturers, write for Special Price in Quantity.

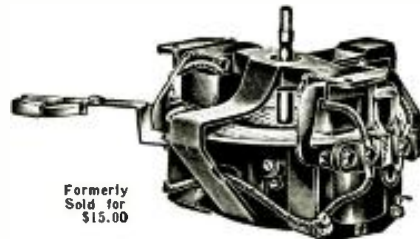

Formerly Sold for \$15.00

**\$3.95** EACH

## WESTINGHOUSE

### Power Generator

Manufactured by the Westinghouse for U. S. Signal Corps. Ball-bearing rotor, ease dimensions 4 1/2" x 6 1/4" diameter. Guaranteed new and perfect. Shipping weight: 13 lbs.

HERE IS WHAT ONE OF OUR CUSTOMERS WRITES:

"These generators are being used in a small fishing village, where the only current is supplied from a 2 K.W.-D.C. generator.

"As it was impossible to use A.C. sets and especially my short wave transmitter using two 15 tubes, one of the generators is used to supply my two A.C. receivers and the other to supply power for the transmitter. Both generators are run by a 1/2 horse-power D.C. motor. These generators perform perfectly and have been absolutely trouble free. The voltage and current regulation is remarkably stable, taking a considerable overload."

—WM. BERG, W 7 BDR, ASTORIA, ORE.



While they last \$4.95

WELLWORTH TRADING CO., RC-734  
 560 W. Washington Street, Chicago, Ill.  
 Enclosed find \$..... for which ship to address below the following:  
 Name .....  
 Address .....  
 City ..... State .....

**Order From This Page**  
**Since We Publish No Catalog**

Remit by check or money order for full amount of each item.  
 No C.O.D.'s. All shipments will be forwarded by express collect if not sufficient postage included with your order.  
**MONEY REFUNDED IF NOT SATISFIED**

**WELLWORTH TRADING CO.**  
**560 W. Washington St., Chicago, Ill.**



## BOOK REVIEW

(Continued from page 59)

"It is impossible even to guess where a development of this kind may stop; it may be possible to carry out the performance of the present-day seven-tube set with only one or two tubes, if these are made sufficiently complex." (The Doctor goes Mr. Hugo Gernsback one better, for, the latter, in his Editorial, "Tomorrow's Radio Set," in the March, 1931 issue of RADIO-CRAFT, more conservatively remarked, "It is conceivable that, ten years hence, we will have a single tube which will do all the work of the four or five tubes used today.")

In another article of interest, entitled, "Modern View of the Electric Current," the author dispels many fallacious ideas that have grown hoary with the generations.

**AUTO POWER**, by S. W. Duncan. Published by Auto Power. Size 5½ x 8½ ins., 36 pgs., 9 plates, 14 figures, paper covers. Price, \$1.00.

### --new RESCO SHORT WAVE CONVERTER

Performance of the new RESCO Short Wave Converter on AC receivers is guaranteed. With plug-in coils covering the complete short-wave range from 20-210 meters, this converter permits tuning on the amateur, aircraft, police and other short-wave bands.



Converter with two coils ranging from 40 to 200 meters, completely built ..... \$1.75 (F.O.B. Phila.)

Additional coil for 20 meter band 50c extra. Prompt, speedy delivery on all orders. Send remittance in check or money order.

**RADIO & ELECTRIC SERVICE CO.**  
Cor. 7th & Arch Sts., Philadelphia, Pa.

### Servicing Vibrators! is a headache ... that we can cure!

HERE'S THE SERVICE You've Been Looking For. Take advantage of our new complete auto-radio vibrator service. All makes of vibrators are completely rebuilt and adjusted. We are thoroughly trained and equipped as specialists in this service.

Very reasonable charges assure you of an excellent profit. . . . all work thoroughly guaranteed.

**NEW YORK AUTO RADIO COMPANY**  
255 Seventh Avenue New York City

### CLASSIFIED ADVERTISEMENTS

Advertisements in this section are inserted at the cost of twelve cents per word for each insertion—name, initials and address each count as one word. Cash should accompany all classified advertisements unless placed by a recognized advertising agency. No less than ten words are accepted. Advertising for the August 1931 issue should be received not later than June 5th.

### ELECTRICAL SUPPLIES

INSULATION, WIRE, VARNISHES, SUPPLIES, etc. Send 3c stamp for bulletin. Antipower, 410 Hoyne Ave., Chicago.

### PATENT ATTORNEY

INVENTORS—Small Ideas may have large commercial possibilities. Write immediately for free book, "How to Obtain a Patent" and "Record of Invention" form. Delays are dangerous in patent matters. Free information on how to proceed. Clarence A. O'Brien, 533-D Adams Building, Washington, D. C.

### RADIO

TRANSFORMERS AND SPEAKER FIELD COILS REWOUND or made to order. Transmitting power transformers. All types of coils wound. Send for circular. Bol Arrow Radio Products, 2801 Grand River, Detroit, Michigan.

This entire volume is built around the sole idea of converting automobile battery-charging generators into A.C. generators, and D.C. motors and generators, of other voltage ratings—especially, 110 V.

The illustrations in this book are models of detail and lucidity. The directions are detailed and explicit. A listing of Chapters indicates the scope of the volume: Chapter I, Changing Ford Model A Power House Type Generator to 110 V. Alternator; Chapter II, Constant Voltage at Variable Speed; Chapter III, Converting Dodge Type GA 12 V. D.C. Generator to 110 V., 500 W. Self-Excited A.C. Generator; and, to 32 V., 500 W. D.C. Generator; Chapter IV, Changing Ford Model T Generator to 110 V., A.C.; and, to 32 V., D.C.; to 32 V., D.C. Motor; and, to 110 V., D.C.; Chapter V, Making Field and Armature Coils; Chapter VI, Changing Delco Generator to 110 V., A.C.; Chapter VII, Testing an Armature; Chapter VIII, Characteristics of D.C. Generators; Chapter IX, Suggestions on Mechanical Construction of Generators; and, Copper Wire Tables; Chapter X, Figuring a New Winding for an Old Frame; Standard Terminology for Wires and Cables; Definitions; Abbreviations and symbols; and, a Price List of Special Components.

This book is printed on high-grade, coated paper stock. Service Men will find it invaluable, especially those whose work continually brings them in contact with automobiles, as they may make considerable money by re-building car generators in accordance with the detailed information contained in this volume.

**RADIO CONSTRUCTION AND REPAIRING**, (Fourth Edition), by James A. Moyer and John F. Wostrel. Published by McGraw-Hill Book Co., Inc. Size 5½ x 8 ins., 444 pages, 190 illustrations, cloth covers. Price, \$2.50.

In the July, 1930 issue of RADIO-CRAFT we reviewed the Second Edition of this volume; it is worthwhile to note that popular demand has necessitated a revision and Fourth Edition of RADIO CONSTRUCTION AND REPAIRING.

This book is planned to provide radio technicians with a complete digest of authoritative radio data, both theoretical and practical, in one logically arranged and thoroughly indexed volume with descriptions, definitions, design data, practical methods of procedure, and illustrations.

Written in a simple, practical manner, it contains many illustrations and diagrams; these include considerable information on testing and trouble-shooting. In the Fourth Edition new sections are found which deal with radio noise-meters, D.C. sets, ultramidget receivers, car radio sets, automotive radio set installation, A.V.C. circuits, tone controls, inter-station noise suppression systems, special antenna systems, new data concerning short-wave reception, and, velocity microphones.

The rapid advance in vacuum tube design is reflected in additional pages devoted to the characteristics of all the new tubes upon which manufacturers have standardized.

## OPERATING NOTES

(Continued from page 32)

### KOLSTER CK—35

IN A Kolster Model CK-35 an open circuit in the flat, wire-wound grid-suppressor, R, in Fig. 4, resulted in the set failing to respond to signals over part of the dial. An inspection and subsequent testing revealed this open circuit—it was beneath the paper jacket which covered the unit. A new metalized ½-W., 2,200 ohm resistor remedied the condition.

(Continued on page 65)

## Specified Parts for the Practical All-Wave LINE NOISE FILTER

Designed by A. D. Lodge

**FOUNDATION KIT \$2.75**

(Regular value—\$4.30)

- 1—Polymet .0055 Moulded Mica Condensers
- 1—Special 100 Turn Duo-lateral Coils
- 1—100 mmf. Trimmer Condenser

## "PERFECTED" ALL-WAVE SET

12,500 MILES ON ONLY TWO TUBES!  
(See Page 523, March Radio-Craft)

Simple to build—easy to operate—World-Wide reception range—and extremely inexpensive! We have sold thousands of these remarkable short-wave kits and noise and "old-timers" alike have marveled at the amazing results obtained.

These kits contain every necessary part to construct the entire receiver. The coils, which tune from 15 to 200 meters, are wound on polished bakelite forms. The attractive crystal finished metal chassis and panel comes with all holes necessary to mount the apparatus and this, together with our complete, detailed, clear instruction sheets greatly simplifies construction. Two Coils 200 to 625 Meters \$1.25  
DRY CELL OR AC MODEL \$4.75

Deposit required with all orders.

## HARRISON RADIO COMPANY

142 Liberty St. Dept. R-7 New York City

## BUILD YOUR OWN



Send for our new Catalog with the complete "Build Your Own" listings for world-beater All-Wave, Short Wave, and regular broadcast sets. Build our famous 2 tube "DX'er" described in the current issue of Short Wave Craft Magazine. Complete kit of quality parts costs only \$6.75 including inexpensively and get thrilling results.

## SOUND MEANS PROFITS

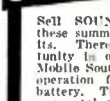

Sell SOUND Equipment during these summer months for big profits. There's a wonderful opportunity in our single unit compact Mobile Sound Systems for complete operation from a 6 Volt storage battery. They're described in our new catalog along with a complete line of A.C. Amplifiers and Sound Systems ranging from 1 to 50 watts in output. If you sell SOUND, you need our book.

## WORLD WIDE RADIO



Our new Catalog which is yours FREE for the asking, lists the very latest All Wave Superhets designed to tune 5 bands for World-Wide reception from 12 to 251.9 Meters. These sensational performers are priced as low as \$30.85 complete in cabinet with tubes. Profit with our All-Wave and Dual Wave Sets. Send for our Catalog today!

## FREE CATALOG

Write for the valuable new ALLIED Catalog. It's FREE. In addition to complete SET BUILDING SOUND, and WORLD WIDE SET listings, you will find radio's most complete stock of standard replacement parts and test equipment at consistently lower prices. Write Dept. D today for your Free copy.

**Allied Radio CORPORATION**  
833 W. JACKSON BLVD., CHICAGO, ILL.

# Follow the crowd they're going "Short-Waves"

## THE OFFICIAL DOERLE Short-Wave RECEIVERS 15-200 Meters



YES, the crowds are going "wild" over short-waves; and the Doerle receivers are making them even wilder. Many have built their own and have obtained miraculous results. Others have purchased them already built and have obtained even better results. And why shouldn't they? These receivers, fundamentally, are so simple that they are absolutely fool-proof. As a result, they work ANYWHERE—not only in this country—but in any location. Day after day, night after night and with amazing regularity, they pull in stations from the far corners of the earth—REGULARLY—always on the same points of the dial.

Only parts of the highest quality, such as Hammarlund variable condensers, etc., are employed; for we fully appreciate that "a short-wave receiver is no better than the poorest part going into its construction." All fancy gadgets and embellishments have been entirely removed, only the most fundamental parts necessary for successful operation are employed. You will be impressed with their simplicity. You will be even more impressed with their operation. These receivers will convince you that foreign reception CAN be obtained—and with uncanny regularity—whenever they are on the air.

The Doerle receivers are available in two types, each type consisting of two models. The Electrified Doerle, both the 2-tube and 3-tube models were designed for those localities where electric service is available. They must be used in conjunction with a specially-designed hum-free A.C. power pack. The 2-volt battery types were designed for the rural districts. They, too, may be had in 2 and 3-tube models.

It may be possible for you to purchase similar receivers or parts for such receivers at greatly reduced prices elsewhere. We admit this at once. But unless you, too, wish to join the ranks of the disillusioned and skeptical short-wave fans you will insist upon the Official Doerle Receivers—Receivers which contain only highest quality parts. All Doerle receivers are built on beautiful, crackle-finished chassis and bear the official name-plate of the only recognized Doerle manufacturer. All 2-tube models measure 9" x 6" x 6 1/2"; 3 tube models 10 1/2" x 7" x 8".



- No. 2140 2-Tube 12,500 Mile Doerle Receiver Completely Wired and Tested. Shipping Weight 5 lbs. **\$9.88**
- YOUR PRICE .....
- No. 2142 Complete Accessories. Shipping Weight 22 lbs. **\$5.38**
- YOUR PRICE .....
- No. 2143 3-Tube Doerle Signal Gripper Completely Wired and Tested. Shipping Weight 7 lbs. **\$12.84**
- YOUR PRICE .....
- No. 2145 Complete Accessories. Shipping Weight 37 lbs. **\$7.19**
- YOUR PRICE .....
- No. 2174 Electrified 2-Tube 12,500 Mile Doerle Receiver Completely Wired and Tested. Shipping Weight 5 lbs. **\$10.44**
- YOUR PRICE .....
- No. 2176 Complete Set of Tubes for Above: Either 1-57 and 1-56 for A.C. operation or 1-77 and 1-37 for battery operation. **\$1.60**
- YOUR PRICE .....
- No. 2177 Electrified 3-Tube Doerle Signal Gripper Completely Wired and Tested. Ship. Wt. 7 lbs. **\$15.29**
- YOUR PRICE .....
- No. 2179 Complete Set of Tubes; Either 1-58; 1-57 and 1-56 for A.C. operation or 1-78; 1-77 and 1-37 for battery operation. **\$2.50**
- YOUR PRICE .....
- No. 2149 Special Hum-Free A.C. Power Pack including No. Re-ticker Tube. **\$7.29**
- YOUR PRICE .....

## Just Imagine! — 2-TUBES in one GLASS BULB



that's the  
"TWINPLEX"  
15 to 200 Meters

The new type 53 tube makes possible this Twinplex "double-action" receiver. This tube actually contains 2 separate tubes in the same glass envelope. Just imagine what this means! It means that a 2-tube receiver can now be built for the price of a 1-tube set. This is exactly what has been done in the Twinplex receiver. A comparison of prices with the Doerle 2-tube receivers listed above will immediately substantiate this statement. And what's more, it actually performs like a 2-tube set. The circuit is practically the same as the 2-tube Doerle—extremely simple and therefore entirely fool-proof. You will receive stations which you never knew even existed before. We have received many letters from satisfied users of the Twinplex receiver praising it to the skies. And justly so, for it is a wonderful little set. It affords full band coverage of from 15 to 200 meters which includes the amateur bands, police and airplane calls, foreign reception and numerous code stations.

Only the finest quality parts such as Hammarlund variable condensers, Kurz Kashi high-ratio vernier dials, etc., are employed. All these parts are mounted in a beautiful, crackle-finished metal chassis which entirely does away with "hand capacity."

The receiver is universal in operation which means that it may be operated either with batteries or with an A.C. short-wave power pack. 180 volts is required for the plates of the tubes and 2 1/2 volts, either A.C. or D.C., for the filaments. For a fan who is first starting in the short wave game, the Twinplex is the most economical receiver with which to begin.

No. 2115 Twinplex "Double-Action" Short-Wave Receiver Completely Wired and Tested, including diagram but less tubes. Shipping Weight 9 lbs. **\$7.50**

YOUR PRICE .....

WE ISSUE NO CATALOG

All orders are F. O. B. New York. Terms: A deposit of 20% is required with every order. Balance may be paid on delivery. Deduct 2% if full amount is sent.

## The "PYTHON" Short-Wave Super Lowest Priced Converter in the World 12-200 Meters-Works with All AC Receivers

COMPLETE  
Nothing Else  
To Buy!



For only \$4.95 you can make your present receiver perform in a way comparable only with expensive short-wave sets. And that is no exaggeration! This means that the range, and therefore the usefulness of your present receiver will be more than doubled; since it will now be able to tune from 550 meters way down to the extremely low wavelength of 12 meters. It means that your present receiver will be able to intercept foreign speech and music, television signals, police calls, and amateur pleasures from all the far corners of the world. Yet without this wonderful little converter is a simple instrument—so simple, that you, or anyone else, without the aid of tools, can easily attach it to any AC receiver in less than five minutes time, and once it is connected it need never again be disconnected, for a convenient toggle switch on its front panel will automatically switch your antenna to either short-wave or broadcast reception. The entire world is going "HUGS" over short waves. You, too, can fall in line with this simple, yet highly efficient short wave converter—a converter which will prove to you that foreign short wave stations CAN be obtained—REGULARLY—whenever they are on the air. **\$4.95**

A four page pamphlet, including radio log, is furnished FREE with each unit. The price of \$4.95 includes three plug-in coils and tube.

## GREN PARK COMPANY

171 Franklin St. Dept. RC New York, N. Y.

RADIO-CRAFT for JULY, 1934



• Index to Advertisers •

<b>A</b>	
Ace Radio Laboratories.....	58
Aerovox Corporation.....	59
Allied Radio Corp.....	61
Apparatus Design Company.....	49
Arco Tube Company.....	55
Autopower, Inc.....	56
Automator Laboratories, Inc.....	53
Automote Mfg. Co.....	51
<b>B</b>	
Bud Speaker Company.....	52
<b>C</b>	
Capitol Radio Engineering Institute.....	42
Central Radio Laboratories.....	46
Clarostat Mfg. Company.....	54
Classified Section.....	61
Coast-to-Coast Radio Corp.....	57
Concourse Electric Company.....	49
Coyne Electrical School.....	1
Curtis Condenser Corp.....	59
<b>D</b>	
Delta Radio Mfg. Co.....	49
Tobe, Deuschmann Corp.....	47
<b>E</b>	
Electrad, Inc.....	52
<b>F</b>	
Fordson Radio Mfg. Company.....	58
Freed Radio Company.....	49
<b>G</b>	
General Control Corp.....	55
General Transformer Company.....	45
Grenpark Company.....	62
<b>H</b>	
Hammarlund Mfg. Company.....	55
Harrison Radio Company.....	61
Hygrade-Sylvania Corp.....	51
<b>I</b>	
Insuline Corp. of America.....	63
<b>L</b>	
L. & L. Electric Company.....	54
Ward Leonard Electric Co.....	56
Leontone Radio Company.....	55
Arthur H. Lynch, Inc.....	54
<b>Mc</b>	
McGraw-Hill Book Company.....	48
<b>M</b>	
Midwest Radio Corp.....	38
<b>N</b>	
National Radio Institute.....	3
National Union Radio Corp.....	53
N. Y. Auto Radio Service Co.....	61
<b>O</b>	
D. W. Onan & Sons.....	49
<b>P</b>	
Pembleton Laboratories.....	56
Pioneer Gen-E-Motor Corp.....	52
Popular Book Corp.....	54
Postal Radio Corp.....	28, 41
Prosto Recording Company.....	40
<b>R</b>	
Radio & Electric Service Co.....	61
Radio City Products Co.....	51, 63
Radio Trading Company.....	64
Radio Training Association of America.....	50
Radolek Company.....	58
Rauch Radio Electric.....	51
Raytheon Production Corp.....	41
RCA Institutes, Inc.....	44
RCA Radiotron Co., Inc.....	37
RCA-Victor Co., Inc.....	Back Cover
Readrite Meter Works.....	49
Remington Rand, Inc.....	56
<b>S</b>	
S. O. S. Corp.....	51
Sexology Magazine.....	56
Shalleross Mfg. Company.....	50
McMurdo Silver, Inc.....	48
Sidar Mfg. Company.....	55
F. L. Sprayberry.....	56
Supreme Instruments Corp.....	39
<b>T</b>	
Triplett Elec. Instrument Co.....	55
Try-Mo Radio Corp.....	56
<b>U</b>	
United Engineering Company.....	59
Universal Microphone Company.....	63
Uron Industries, Inc.....	49
<b>V</b>	
VanLouver Laboratories.....	59
<b>W</b>	
Webster Company.....	57
Wellworth Trading Company.....	60
Weston Electrical Instrument Co.....	43
Wholesale Radio Service Co.....	53
Wright-DeCoster, Inc.....	42, 47

(While every precaution is taken to insure accuracy, we cannot guarantee against the possibility of an occasional change or omission in the preparation of this index.)

OPERATING NOTES

(Continued from page 61)

MOHAWK LYRIC 90

**I**N A Mohawk Lyric Model 90 using a double push-pull audio output stage, shown at A in Fig. 5, faint reception was traced to an open in one-half the input transformer to the 45's in push-pull. Not being able to get the type 184A unit, I used the system shown at B with excellent results. I have used an equivalent arrangement, but with only one resistor and condenser, as shown at C, for repairing single audio stages in which the primary was burnt out. Excellent results in tone and volume have been obtained in all cases.

ZENITH CH-2012-4J

**A**N ANNOYING case of intermittent reception was encountered in a Zenith Model CH-2012-4J, an 8 tube superheterodyne incorporating A.V.C., but without a tuning meter. Tubes checked O.K. when tested, as also did voltages, current readings, condensers, resistors and coils. Still the set would operate satisfactorily only for a couple of hours, then suddenly become as silent or dead as the well-known door nail whereupon, tapping the oscillator tube, it would again start to function normally. This defective "intermittent" oscillator tube was located by repeated tapping of all the tubes that might be defective—but only after many blessings had been called down on the set.

DeFOREST-CROSLY MODELS

Minstrel .....810, 1930-'31  
 Area .....740, 1930-'31  
 Troubador .....750

**D**EFOREST-CROSLY models hum loudly when the 3 section, single-unit Mershon electrolytic condenser fails. I have remedied three or four cases of the above trouble by drilling a small hole in the hard rubber top, filling up to about 1/2-in. from the top with distilled water, and sealing the hole with wax. The hum in every case has disappeared and they have been satisfactory to date.

Also, I have replaced the 3-section, wet Mershon filter condenser with another (made by Polymer Co., Ltd., of Hamilton, Canada) consisting of 3, 500 V., 8 mf. units sealed in an aluminum can of practically the same dimensions as the Mershon copper can. The common negative side in the Polymet product is not grounded to the can but is denoted by a separate black wire brought out through the fibre top of the condenser.

MAJESTIC 20

**S**OME time ago I was called in to service one of the above models in which the complaint was that the tone control "acoustic-static" control, as it is referred to by Griesby-Grinow) wasn't working. The knob on the tone control would turn to the correct position but no change in tone occurred, despite the fact that the knob was securely wedged on the shaft. On examination, after removing the chassis, it was found that the whole tone control unit was being turned at the same time the control knob was. In fact, one of the wires soldered to the unit was broken, and the nut or bolt that screwed onto the brass collar holding the control unit to the chassis was loose, allowing the whole unit to make a complete revolution when the control knob was rotated. However, the real trouble was found in the control unit itself. The steel shaft and contact arm that rotates inside the brass bushing had become so rusty inside the brass bushing that it would not turn at all. Penetrating oil was placed around it and the shaft was finally loosened. Then I removed it, polished it with emery cloth, and reassembled the unit which consists of a fixed condenser across the input of the power amplifier stage. Incidentally, I might also mention that due to the peculiar chassis construction of these models it is necessary to remove the screws from the ends of the chassis before attempting to lift up the bottom and unsolder a half-dozen wires. This is absolutely necessary before the chassis can be inspected thoroughly. The above procedure will save considerable work and temper in the end.

HARRY G. MITCHENER

RCP • RCP • RCP • RCP • RCP • RCP • RCP

**New!**  
**A LIGHT TO GUIDE YOUR TEST PRODS**

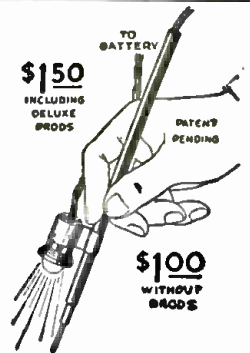

**SEE** what you are testing with the R.C.P. "PROD-LITE." A brand new, practical help for service men for all dark, tight places—especially in testing automobile radios. All ready to use. Adjustable distance clip fits standard prods. No exposed terminals. Mailed C.O.D. \$1.50, plus postage, complete with standard flashlight battery in switch-top container (easily carried in pocket), bulb, cord and deluxe prods. \$1.00 without prods. Order "PROD-LITE" Today. Send remittance and save postage. If not satisfied, return in five days for refund. Use convenient coupon.

**DISTRIBUTORS—Write for Proposition.**

**RADIO CITY PRODUCTS CO., RC-7**  
 48 West Broadway, New York City

I accept your offer as advertised. Please send "PROD-LITE" C.O.D. ....Check here if prods also are wanted. ....Check here if enclosing remittance to save postage.

Name .....  
 Address .....



**SHORT WAVE CONVERTERS**

Easy to Connect and Operate Work With Any Electric Set

The "Marvel" for A.C. Sets

Brand new! Connects in a jiffy to any A.C. electric set. Brings your present set up-to-date. Utilizes the entire receiving circuit of your set plus power pack making it a super-het all-wave receiver. Comes in bakelite cabinet. Wave length: 20-200 meters. Our low list price, less tube, \$9.50.



Your net cost at 40% off ..... **\$5.70**

The "Scout" for either A.C. or D.C. Sets

A converter without a peer for DeLuxe performance. Gets Europe easily. Comes in beautiful walnut cabinet. Wave length: 20-200 meters. Uses the new No. 37 and 6A7 tubes. Operates with any set. List price complete with tubes and coils, \$17.50. Your net cost at 40% off ..... **\$10.50**



Both sets switch from S.W. to Broadcast band without disconnecting.

**ORDER TODAY!**

From your jobber or favorite M. O. House or write us direct. Get our new catalog of S.W. accessories with 16 free diagrams.

**INSULINE CORP. OF AMERICA**  
 23-25 PARK PLACE NEW YORK, N.Y.

Dept. C-74

Send me further details of the Marvel and the Scout Converters.

Send me the name of nearest ICA jobber  
 Send me your FREE S.W. catalog.

Name .....  
 Address .....  
 City ..... State .....



**UNIVERSAL**

**Double-Button Hand-Mike**  
 Dealer's Net Price \$8.82

An exceptionally clear, highly damped hand microphone—Truly natural tone—is ruggedly built. No delicate parts to be damaged. For announcing, transmitting and home recording. The most efficient general utility hand microphone that could be built.

**UNIVERSAL MICROPHONE COMPANY, Ltd.**  
 424 Warren Lane  
 Inglewood, Calif. U.S.A.



# RTC's Big July SPECIALS

## YOUR DOLLAR — IS WORTH MORE When You Buy From Us

Is the dollar inflated? These days everybody is speaking of inflation but why worry about it, whether the dollar is inflated or not it is worth more when you buy from us. The prices shown on this page are so radically low that no one can possibly undersell them. Our consistent advertisement, present to you each month, on this page, certain **STAR (\*)** items which are not listed in our regular catalog. These are all specials of which the small quantity on hand does not permit us to catalog them. **ONCE SOLD OUT NO MORE CAN BE HAD AT ANY PRICE. ORDER TODAY—NOW.** Order direct from this page and save money. 100% satisfaction guaranteed on every transaction.

We are a wholesale house and cannot accept orders for less than \$3.00. If C.O.D. shipment is desired, please remit 20% of the total amount of your order. Balance will go forward C.O.D.

If full cash accompanies your order deduct 2% discount. Send money order, certified check or U. S. stamps.

Be sure to include sufficient extra remittance if order is to be shipped via parcel-post; any excess will be refunded.



## FREE

### RADIO and Short-Wave TREATISE

108 Pages 1500 illus.

Completely revised and enlarged, this new 1934 edition contains 108 solid pages of useful radio information, diagrams, illustrations, radio kinks and real live radio merchandise. It contains more valuable radio information—more real live "meat"—than many text books on the subject. **PARTIAL LIST OF CONTENTS:** Fundamental Principles of Radio for the Beginner, Chapter 2—Fundamental Circuits and Uses of New Tubes—Revolving Six Volt Battery Sets for Two Volt Tubes—Tubing Adapters—Sets—How to Build Short Wave Transmitters and Receivers—Up to Date Tube Chart and Socket Connections, etc., etc. **WRITE TODAY**—Enclose five cents (coin) for postage. Treatise sent by return mail. Print name and address clearly on request.

## GREATEST SET BUY IN AMERICA!

### ★ Famous Wright-DeCoster VII Battery Receiver

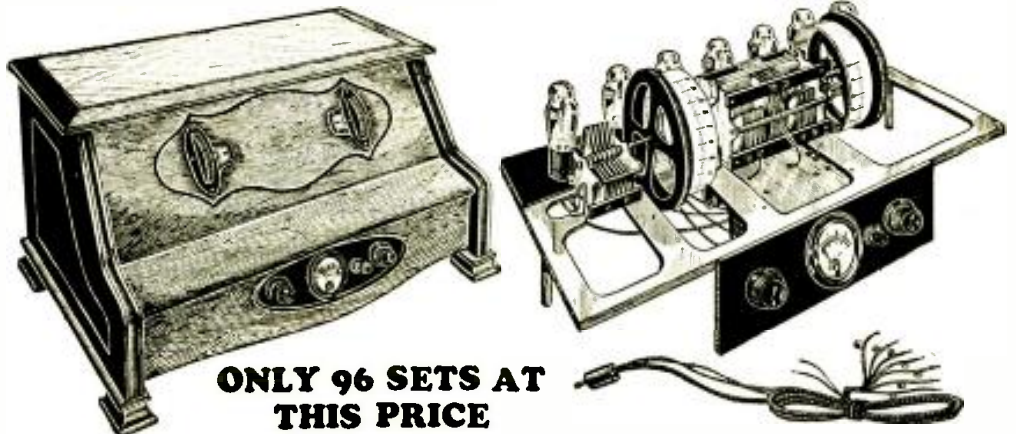

**ONLY 96 SETS AT THIS PRICE**

**\$14.96**

If there ever was a greater value than this one offered before, we have yet to see it. The Wright-DeCoster VII receiver, in its prime, several years back sold for \$300.00, and tens of thousands of them were sold, yet now you can buy this same set unused and in factory sealed cartons for only a fraction of that price, to be exact \$14.96! Why, the parts alone in this receiver, if taken out and sold separately would net you more than \$25.00; to say nothing of the beautiful cabinet. The dual scale, genuine Jewell meter alone, today, sells for more than \$5.00.

But aside from all this, the set itself affords remarkable performance. The selectivity and sensitivity, due to its 4-tuned stages are just as sharp as a modern super-heterodyne receiver. The circuit is of the tuned radio frequency type designed originally for 6-UX-199's and 1-UX-129, however, 2-VOLT OPERATION MAY BE OBTAINED WITHOUT ANY CHANGE IN THE CIRCUIT BY MERELY INTERCHANGING THE '99 TUBES WITH 30'S AND THE UX-129 WITH A 31. The use of the 2-volt tubes steps up the overall gain and volume of the set enormously. The circuit comprises 3 stages of R.F. amplification, one detector and 3 stages of audio amplification. It tunes in, and completely separates, stations of the same approximate wave-lengths with facility—a quality so necessary to the enjoyment of the present day radio with its ever increasing number of broadcast stations of very similar wave-lengths.

Furthermore the range of this receiver is so great that it will bring in the most distant station. We do not hesitate a moment in recommending it, especially to suburbanites and others living in rural districts. It is an ideal farm set

where electricity is not available. The set is designed for the greatest comfort of the operator. All unnecessary controls are eliminated. The tuning dials may be illuminated for night operation by turning a switch on the panel. The Jewell meter on the panel affords an indication of the voltage on the tube filaments and thereby protects them.

THE WRIGHT-DECASTER VII does not radiate or cause interference of any kind. It gives maximum efficiency on all broadcast ranges and will operate with any length of aerial. If used with the 99 and 20 tubes, 1 volt of "A" current, 135 volts of "B", 22½ volts of "C" are required. If used with 30 and 31 tubes only 3 volts of "A" (2 No. 6 dry cells arranged in series), 135 volts of "B" and 16½ volts of "C" are required.

The cabinet, made of black walnut with satin finish is of a very beautiful design. The dial readings are directly in front of the operator's eyes and fine tuning is obtained by thumb action. The receiver can be used with any good magnetic speaker or even with a permanent magnet dynamic speaker if one is handy. The set measures 24" long x 15" wide x 12" high. Shipping weight 45 lbs.

No. 3000 Wright-DeCoster VII Battery Receiver.

**YOUR PRICE, Less Tubes.....\$14.96**

Set of 6-230 and 1-231 guaranteed Neontron RCA licensed tubes .....\$5.25

**ONLY 96 AT THIS PRICE. ONCE SOLD NO MORE WILL BE HAD. WE BOUGHT THE ENTIRE SUPPLY FROM MANUFACTURER. NO ONE ELSE HAS THESE FINE SETS.**



## WORLD-WIDE RECEPTION WITH THE FAMOUS "TWINPLEX" Short-Wave Receiver

**2-Sets in-1**

**Economical 2-Volt Operation Complete with Headphone**



**ONLY \$4.96**

**S**hort waves are the talk of the hour. The whole country, nay, the whole world, has gone crazy to receive foreign stations, as far as 12,500 miles distant. Usually, such reception is had only with expensive multi-tube sets.

Only recently, the invention of the "19" tube has made it possible to perform the function of two tubes in a single tube. Then came the invention of the TWINPLEX, a radio circuit of unheard of sensitivity, using the "19" tube; it is now possible with a single tube of this type to receive short wave stations from all over the world, loudly and clearly—REGULARLY, night after night, day after day, always in the same place on the dial.

Every radio man knows that in a short-wave set it is highly important to have the wiring as short as possible. By inventing a radically new design, that is, by mounting tube and coils, in fact, everything, on the front panel, it has become possible to shorten all connecting wires, with the result that an UNHEARD OF SIGNAL SENSITIVITY has now been achieved for the first time, in a single-tube set.

But the TWINPLEX is ACTUALLY A TWO-TUBE SET; yes, we repeat, A FULL-FLYING TWO-TUBE SET AT THE PRICE OF A ONE-TUBE SET. JUST IMAGINE TWO TUBES IN ONE GLASS ENVELOPE. That is the story of the new "19" tube. It is a 2-volt tube, which has a DOUBLE SET OF ELEMENTS.

This set has been so designed that it will receive ordinary broadcast stations too—stations which come in with great volume, particularly local stations. These come in

so loud that if you have a loud-speaker, this little one-tube set will ACTUALLY GIVE YOU LOUDSPEAKER RECEPTION.

With this set, we furnish regularly, two coils, one a short-wave plug-in coil, which receives all the popular stations in the 33 to 65 meter band, and a broadcast coil which receives nearly all broadcast stations.

A simplified instruction sheet with detailed instructions and pictorial diagrams shows you how to build the set in a few hours' time, and once you have completed the set, FROM THEN ON, YOU DON'T SLEEP ANY MORE.

ONLY FIRST CLASS MATERIAL, such as Hammarlund tuning condensers, Poly-met mica condensers, R.M.A. standard resistors, etc., are employed.

The "19" TWINPLEX is available ONLY in kit form and comprises all parts to properly build the receiver in from 1 to 2 hours. ANYONE CAN DO IT. Shipping weight 5 pounds.

No. SW-308 Famous Twinplex Short-Wave Receiver Kit with all parts INCLUDING SINGLE HEADPHONE AND BAND BUT NO TUBE **\$4.96**

**YOUR PRICE**

No. SW-309 Complete Accessories For TWINPLEX Receiver, comprising 1-Type 19 Tube, 2-No. 6 Dry Cells, 2-45 volt "B" Batteries. Shipping weight 20 pounds. **\$3.57**

**YOUR PRICE** ..... Additional Plug-in Coils—45c each

**RADIO TRADING COMPANY, 97 Hudson Street, New York City**



# Service Men's Essentials for All Members of the

# ORSMA



No. 14—50c each  
(Plus 10c for Postage)

No. 3—60c per pad of 50  
\$3.00 per ten pads, each of 50



No. 5—50c each

## SERVICE MEN'S ESSENTIALS

THE OFFICIAL RADIO SERVICE MEN'S ASSOCIATION has made arrangements to supply a number of "Service Men's Essentials" for the use of its members and associate members. Only members and associate members can buy these items; they are not sold to others.

These essentials are priced at cost, plus a small additional fee which is the only source of income that the Association has. No one obtains any profit or benefit, except the Association itself. Whatever profit accrues is reinvested for the furtherance and enlargement of the Association.

By using the letterheads, billheads, etc., you present the business-like appearance to your customers, so essential to successful servicing. In addition, the Association has made arrangements with most of the prominent manufacturers to allow special discounts to members, providing ORSMA letterheads are used when ordering.

### No. 1 ORSMA LETTERHEADS

These letterheads, shown on the right, are furnished with your name, address and telephone number, printed on excellent paper. They are sold in lots of 100 or multiples thereof, with a distinct saving for single orders of 1,000 or more. You would have to pay many times more if you ordered small lots from your local printer. Per 100, 60c; per 1000, \$3.00.

### No. 2 ORSMA ENVELOPES

These are furnished to match the letterheads, printed with your name and address and seal of the Association. They go hand-in-hand with the letterheads and are usually ordered in the same quantity. Per 100, 60c; per 1000, \$3.00.

### No. 3 ORSMA SERVICE RECORD CARDS

They serve a double purpose; whenever you complete a job you fill out the report-bill and hand it to the customer; this is the "psychological moment" to collect. By the use of carbon paper a permanent record is kept which is a valuable asset to your business. They are furnished with your name, address and telephone number. Per pad of 50, 60c; per 10 pads, each of 50, \$3.00.

### No. 4 ORSMA INSPECTION LABELS

The label is to be filled in with the proper dates, and pasted inside the set or cabinet where the customer will see it. It is a continuous reminder to him that, when service is needed, he can call you again. The advantage is apparent. Per 100, 50c; per 1000, \$3.00.

### No. 5 ORSMA LAPEL BUTTON

At the suggestion of many members a handsome lapel button bearing the name and emblem of the Association has been designed. It signifies to your fellow members that you belong to the same Association;—and in addition it gives your customers a better appreciation of the professional nature of your work. 50c each.

### No. 6 ORSMA BUSINESS CARDS

These are furnished on a fine grade of paper in two colors with a blotter back. Thus they present an added incentive to your customer to keep them in a prominent place, where they will do the most good. They are printed with your name, address and telephone and bear the official seal of the Association. Per 100, 75c; per 1000, \$4.00.

### No. 9 & 10 ORSMA EMBLEM CUTS

These cuts for printing, advertising, etc., are furnished in two styles and sizes. They may be used for newspaper or telephone-book advertisements or for printing of any kind. Large size, 1 1/4 x 1 1/4 in., \$1.35 each; small size, 3/4 x 3/4 in., \$1.20 each.

### No. 11 ORSMA MEMBERSHIP SIGN

A set of three of these signs, printed on heavy cards, and having holes punched in order to hang in your office or store, and are sold to members and associate members. They are large enough so that they are quite prominent and the two tone effect makes a very attractive appearance. Set of three, 50c.

### No. 12 ORSMA ADVERTISING DISPLAY SIGN

A two color sign printed in large letters with your name, address and telephone, with the seal of the Association. This sign is sold in quantities of 25 or more and is ideal for hanging in stores, offices, etc., for advertising purposes. Set of 25 cards, \$3.00.

### No. 13 RADIO SERVICE MEN'S ASSORTMENT PACKAGE

This includes one gold filled lapel button, 100 letterheads, 100 envelopes, 50 service record cards, and 100 labels printed with your name and address as described above. The whole assortment costs only \$3.00—a worth-while saving. Complete, \$3.00.

### No. 14 ORSMA MEMBER CERTIFICATE

A handsome diploma-like certificate engraved on stiff vellum-board. The certificate is personally signed by the President and Executive Secretary and the corporation stamp of the Association is impressed on a red seal attached to it. Your name, certificate number and date of registration are lettered by hand and the Certificate is mailed in a cardboard tube to insure safe delivery. Each 50c, plus 10c for postage.



No. 1—60c per 100  
\$3.00 per 1000



No. 2—60c per 100  
\$3.00 per 1000

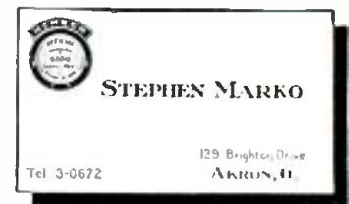

No. 6—75c per 100  
\$1.00 per 1000

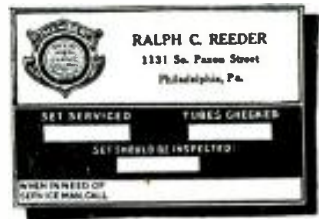

No. 14—60c per 100  
\$3.00 per 1000

Mail This Coupon Today!

## Application for Membership in ORSMA

Executive Secretary, ORSMA  
99 Hudson Street, New York, N. Y.

Kindly send an application blank for

- Full Membership
- Associate Membership

Name .....

Street or Box .....

City ..... State .....

RC-734

## OFFICIAL RADIO SERVICE MEN'S ASSOCIATION

RC-731

99 Hudson Street, New York, N. Y.

Please send me the following RADIO SERVICE MEN'S ESSENTIALS which I have selected from this advertisement. My remittance for \$..... is enclosed. Send remittance in form of check or money order. Register letter if it contains cash, currency or unused U. S. Postage Stamps.

.....

.....

.....

.....

.....

Name .....

Address .....

City and State .....

.....

.....

.....

.....

.....

.....

.....

.....



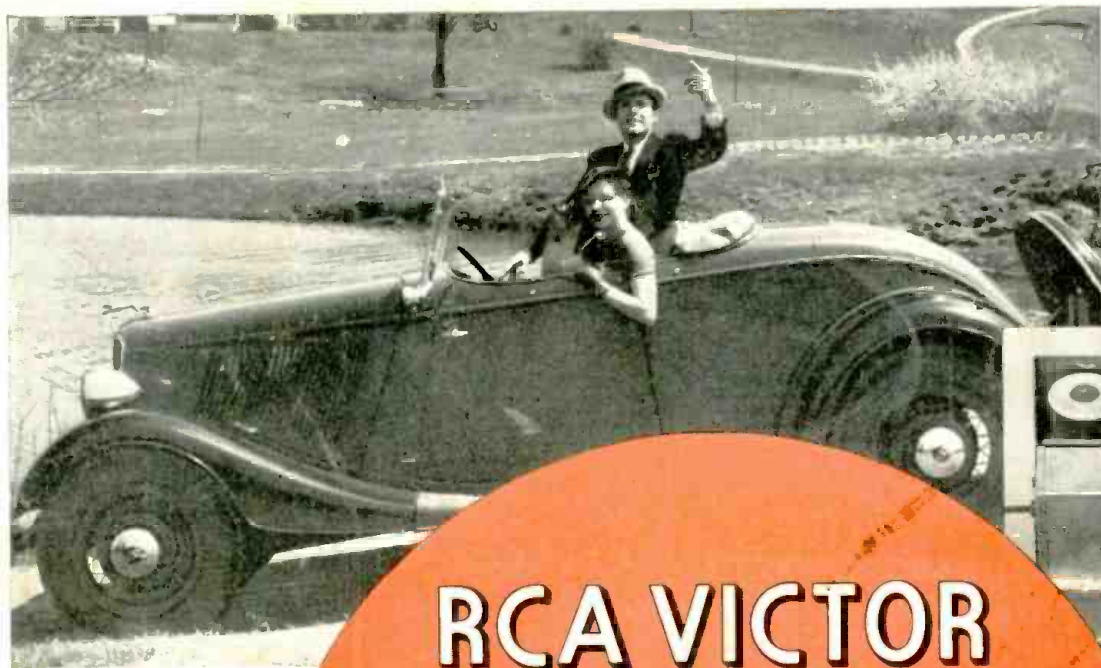

**RADIO HEADQUARTERS**  
Engineering...Class B amplification makes for economical operation and good fidelity. Automatic tone control. More exclusive features than any other. Look at this workmanship —you can't go wrong on an RCA Victor Auto Radio, Model M-123!

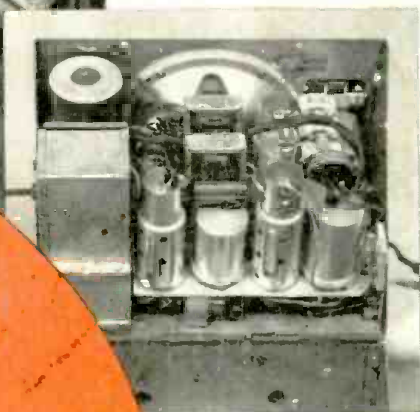

**RCA VICTOR**  
*new de luxe*  
**AUTO RADIO**  
*scores tremendous hit!*

OFF FOR A DAY of Delight...and with an RCA Victor Auto Radio, Model M-123 as companion, it's twice as much fun. All programs come in clear, sharp, distinct and with amazing tone.

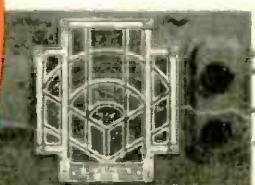

... now all of radio's great programs brought in anytime, anywhere as you ride, park or picnic, in superb model with thrilling realism and delightful tone

**MODERN DESIGN**... to fit the new cars, or blend with the older. A complete unit, easily installed, efficient in operation, Model 123 is a 6-tube superheterodyne, RCA Victor Auto Radio.

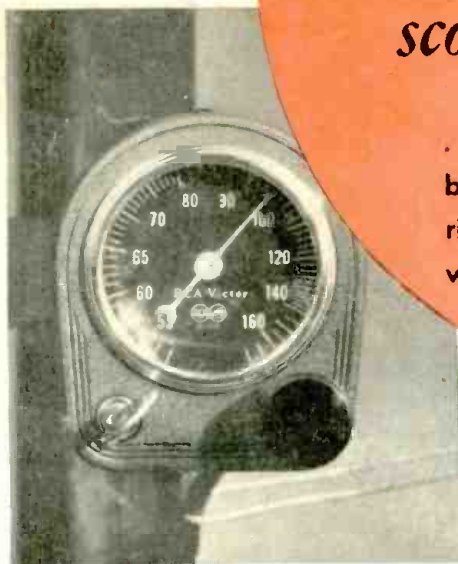

**CONVENIENT OPERATION** . . . marks M-123. An "airplane-type" dial that is illuminated. Geared for accuracy in station selection, you get the program you want whenever or wherever you want it... on the road, at the summer camps or cottages, at the beach — everywhere!

**A TURN OF A SWITCH**...and your car is flooded with music. M-123 operates with the motor on or off...or at any speed. RCA Radiotrons assure perfect reception, too!



**RCA VICTOR CO., Inc.**

Camden, New Jersey — "Radio Headquarters"